

How To Contact Us

For nearly 60 years, OEM designers, maintenance and materials engineers around the world have trusted the Molykote® brand for performance and expertise to solve or prevent lubrication problems. Molykote solutions are available through a distributor network of more than 3,000 channel partners around the globe. To learn more about our extensive product and service offering, visit www.molykote.com or email industrial@dowcorning.com.

LIMITED WARRANTY INFORMATION - PLEASE READ CAREFULLY

The information contained herein is offered in good faith and is believed to be accurate. However, because conditions and methods of use of our products are beyond our control, this information should not be used in substitution for customer's tests to ensure that Dow Corning's products are safe, effective, and fully satisfactory for the intended use. Suggestions of uses should not be taken as inducements to infringe any particular patent.

Dow Corning's sole warranty is that the product will meet the Dow Corning sales specifications in effect at the time of shipment.

Your exclusive remedy for breach of such warranty is limited to refund of purchase price or replacement of any product shown to be other than as warranted.

DOW CORNING SPECIFICALLY DISCLAIMS ANY OTHER EXPRESS OR IMPLIED WARRANTY OF FITNESS FOR A PARTICULAR PURPOSE OR MERCHANTABILITY.

DOW CORNING DISCLAIMS LIABILITY FOR ANY INCIDENTAL OR CONSEQUENTIAL DAMAGES.

Dow Corning and *Molykote* are registered trademarks of Dow Corning Corporation.

© 2004 Dow Corning Corporation. All rights reserved. Form No: 71-0250B-01

DOW CORNING



MOLYKOTE[®]
FROM DOW CORNING

Anti-Friction Coatings Selection Guide

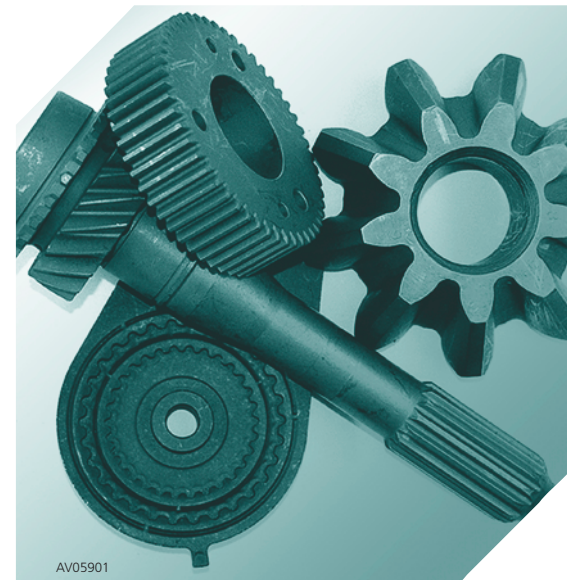

AV05901

Resistance of cured film layer

Anti-Friction Coating product	Fuels	Brake fluid	Acids	Alkalines	Aromatics	Alcohols	Deionized Water	Ketone	Cutting fluids	Mineral oils	Synth. Oils	Dewatering fluids	Detergents	Radiation	Dielectric strength	Paintability
D 321R	●	●	●	✘	●	✘	✓	●	●	●	●	●	✘	✓	●	✘
3402-C	✓	✘	✘	✘	✓	●	✓	●	✓	✘	✘	✓	✘	✘	✘	✘
D 3484	✓	✓	✘	●	✓	✓	✓	✓	✓	✓	✓	✓	✘	-	●	✘
3400A Leadfree	✓	✓	✘	✘	✓	✓	✓	✓	✓	✓	✓	✓	✘	✓	✓	✓
106	✓	✘	✘	●	✓	✓	✓	✓	✓	✓	✓	✓	✘	✓	●	✓
7409	✓	✓	✓	✘	✓	✓	✓	✓	✓	✓	✓	✓	✓	✓	✘	✓
7620	✓	✓	✓	✘	✓	✓	✓	✓	✓	✓	✓	✓	✓	✓	✘	✓
7400	✘	✘	●	●	●	✘	✘	●	✘	●	✘	✘	✘	-	-	✘
D 106	✓	✓	✓	✘	✓	✓	✓	✓	✓	✓	✓	✓	✘	-	-	✓
PTFE-N UV	✘	✘	✘	✘	●	✓	✓	●	✘	✓	✘	✘	✓	-	✘	●
D 708	✓	✓	✓	✘	✓	✓	✓	✓	✓	✓	✓	✓	✓	-	✓	●
D 96	✘	●	●	●	●	✘	✘	●	-	✘	✘	-	-	-	✘	●
7405	✘	●	✘	●	✘	✓	✓	✓	✓	✓	✓	✘	✓	-	✓	●
D 10	✓	✓	✓	✘	✓	✓	✓	✓	✓	✓	✓	✓	✓	-	✓	✘
D 88	✓	✓	✓	✘	✓	✓	✘	✓	✓	✓	✓	✓	✓	-	-	✘

✓ = excellent ✘ = good ● = limited - = n.a.

Application engineering

Our application facility is another strong asset of our technology leadership. In this dedicated laboratory area the most common application machines for Anti-Friction Coatings are in operation to produce prototype samples for customers, or for optimising the application parameters for new projects.

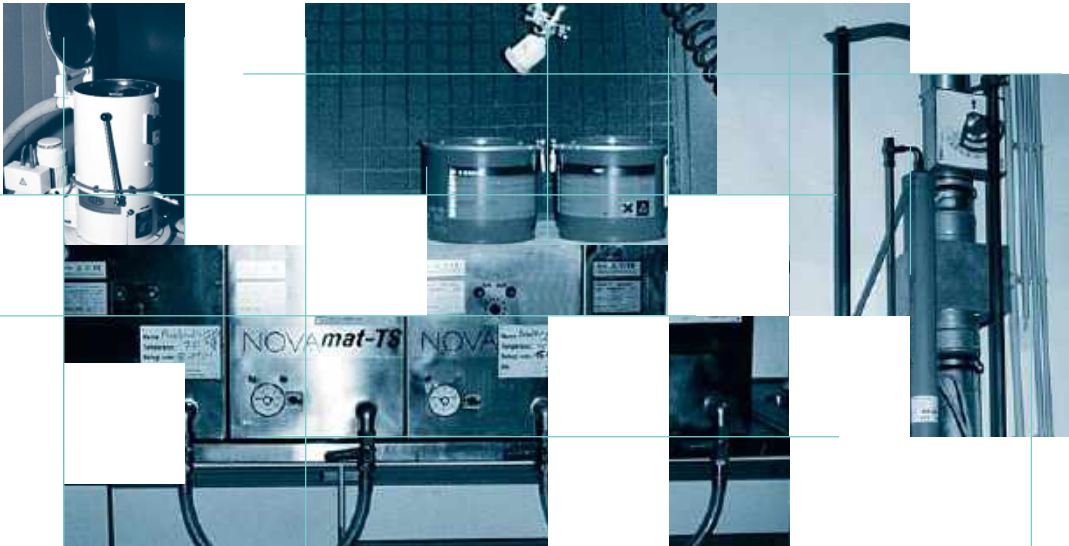

MOLYKOTE® Anti-Friction

Anti-Friction Coatings (formerly known as bonded coatings) are paint-like products. They contain, instead of a colouring pigment, submicron-sized particles of solid lubricants dispersed through carefully selected resin blends and solvents.

Important for the lubricating and corrosion protection properties are the choice of the raw materials and the volume concentration of the lubricant content. MOLYKOTE®

Anti-Friction Coatings form a slippery film, which covers all surface roughness and thus optimises metal-to-metal, metal-to-plastic or plastic-to-plastic friction even under extreme loads and working conditions. These coatings can be applied by conventional painting techniques: spraying, dipping or brushing.

MOLYKOTE® Product line

Product	Lubricant
D 321R	MoS ₂
3402-C	MoS ₂
D 3484	MoS ₂
3400A Leadfree	MoS ₂
106	MoS ₂
7409/7620	MoS ₂
D 106	MoS ₂
7400	MoS ₂
PTFE-N UV	PTFE
D 708	PTFE
D 96	PTFE
7405	Synth.
D 10	Graphite
D 88	Special pigments

Footnote:

L13 is a mixture of organic solvents
7414 is an organic solvent with
flash-point >90°C

Curing

Heat cured coatings exhibit better resistance values. The corresponding curing times and temperatures are given in the data sheets. These are guidelines, which need to be verified under production conditions. The curing time must be extended for large parts, depending on weight and cross-section. Paint drying circulation ovens are recommended. It is also possible to use infra-red heat for curing. A wipe test using MOLYKOTE® 7414 thinner is recommended as a check of complete curing. If the coating is removed, the film is not fully cured.

Coating thickness

The film thickness has a considerable influence on the service life, coefficient of friction and anti-corrosion properties of Anti-Friction Coatings. It should be greater than the surface roughness of the mating surfaces and is generally between 5 and 20 µm. It is better to apply as thin a coat as possible to both surfaces, rather than a relatively thick coat on only one surface, since thicker layers cannot stand as heavy mechanical loads.

The following methods can be used to measure the layer thickness:

1. Magnetic method in accordance with DIN 50 981/ISO 2178 on ferromagnetic basic substances.
2. Eddy current method in accordance with DIN 50 984/ISO 2360 on non-ferrous metals.
3. Beta back-scatter method in accordance with DIN 50 983/ISO 3543 on plastics.
4. In exceptional cases (when the above methods are not available), micrometer and optical methods.

Removal of Anti-Friction Coatings (stripping)

In most cases, Anti-Friction Coatings can be removed from metal surfaces by placing the parts in MOLYKOTE® 7414 thinner overnight. Should this fail to produce the desired result, commercial paint removers for epoxy resins can also be used. Another efficient method (if permitted) is sand-blasting the coated surfaces.

Application to plastic surfaces Selection

When choosing the Anti-Friction Coating, bear in mind that coatings containing MoS₂ are suitable for reinforced plastics, and MoS₂-free coatings for non-reinforced plastics. If a thermosetting Anti-Friction Coating is preferred to an air-drying Anti-Friction Coating, conduct a test beforehand to determine whether the plastic has sufficient thermal stability.

Application methods

Anti-Friction Coatings can be applied by spraying, dipping, brushing, roll coating and printing. The chosen method will depend on the shape, size, weight and quantity of the components. Consideration must also be given to the film requirements, as well as to the proportion and location of the sliding surfaces being coated.

Drying/curing

This depends on the coating used and can be obtained from the data sheets. Trial coating and testing for stress crack formation are required.

Application of Anti-Friction Coatings (continued)

Dipping individual components

Big bolts, bushings, rods, sections, tubes, etc. and in general flat parts which cannot be treated in a dip-centrifuge can be coated in a dipping bath, and then allowed to drip-dry. Use a controlled dipping action to prevent air from being dragged in. Adjust withdrawal speed to prevent tears and droplet formation and to regulate the desired film thickness. Circulate the contents of the dipping bath with a suitable pump and an overflow lip. When using Anti-Friction Coatings containing organic solvents, arrange an edge extractor directly above the maximum level. During a stoppage, cover dipping containers to minimize evaporation and prevent contamination.

Brush application

Anti-Friction Coatings can also be brushed on. Even with fine-bristled brushes, the resulting film is often irregular. Consequently, consider alternative methods.

Roll coating and printing

Anti-Friction Coatings can be applied with standard coil-coating machines, but simpler transfer roll coating methods can also be used. Silk-screen and pad printing techniques are used for partial application.

Suitability for coating methods

AFC-Product	Centrifuging	Paint/ spraying drum	Automatic dipping	Automatic spraying	Brushing	Printing	Coil- coating
D 321R	✘	●	✓	✓	✓	●	-
3402-C	✘	✘	✓	✓	✓	✘	✓
D 3484	✘	✓	✘	✓	✘	●	✓
3400A Leadfree	✓	✓	✘	✓	✓	✘	✓
106	✘	✘	✘	✓	✘	●	✓
7409	✘	✓	✓	✓	✘	✘	✓
7620	✘	●	✓	●	✘	✓	✓
7400	✘	●	✘	✓	✓	●	●
D 106	✘	✘	✘	✓	✘	●	✓
PTFE-N UV	●	●	●	✓	✘	●	●
D 708	✓	✘	✓	✓	✘	✘	✓
D 96	✘	●	✘	✓	✘	✓	●
7405	✘	✘	✓	✘	✓	✓	✓
D 10	✘	✘	●	●	●	✓	✓
D 88	✘	✘	●	●	●	✓	✓

✓ = excellent

✘ = good

● = limited

Coatings

Other common application methods are spraying drums, centrifuges, electro-static or automatic spraying, printing or roller coating followed by well-known methods of industrial drying and curing. The time required for these drying and curing methods is between 3 minutes air drying and 60 minutes oven curing.

The Anti-Friction Coatings Product Line

The current product line can be differentiated by the various solid lubricants, binders and solvent bases contained in the formulations.

Binder	Thinner-compatible solvent
Titanate	L 13
Special	L 13
Phenolic	L 13
Epoxy	L 13
Epoxy	L 13
Polyamide-imide	7414
Epoxy	Water
Acrylic	Water
Acrylic	L 13
Epoxy	L 13
PU	Water
Polyamide-imide	7414
Polyamide-imide	7414
Polyamide-imide	7414

Strengths/Potential weaknesses Technologies

1. Lubricating Substances

Type	Strengths
MoS ₂ Molybdenum Disulfide	<ul style="list-style-type: none"> + High load carrying capacity + Wide temperature range + Paintable + Excellent adhesion + Low coefficient of friction at high loads + Protects against fretting corrosion + Increases lifetime (Synergism with graphite) + Electrical insulator
Graphite	<ul style="list-style-type: none"> + High temperature stability + Separating effect (metal-forming) + Good lubricant under humidity
PTFE	<ul style="list-style-type: none"> + Colourless + Separation effect + Low coefficient of friction at low load + Electrical insulator + Good chemical resistance
Synthetics	<ul style="list-style-type: none"> + Colourless / colourable + Extreme low coefficient of friction at low loads (curing temperature) + Good chemical resistance + Good fretting corrosion protection + Low curing temperature + Electrical insulator

Application of Anti-Friction Coatings

Depending on the nature of the parts being treated and the surface finish required, Anti-Friction Coatings are applied by spraying, dipping, or by using paint/spraying drums and centrifuges. The components should be appropriately pre-treated. In the case of partial coating of the components, it is advisable to use masking stencils or removable protective film. These must be removed before curing. Anti-Friction Coatings are supplied ready for use according to the recommended application processes (see technical data sheet of the considered product). Before application they need to be stirred thoroughly in order to obtain a uniform fluid. Only in cases where the film thickness has to be below 5 µm, it is necessary to dilute, stirring thoroughly. When handling non-water-based Anti-Friction Coatings use only electric mixers with explosion-proof motors. When applying such coatings, always comply with local safety regulations for handling paints and varnishes.

Application to metal surfaces

Spraying

Apply sprays in spray booths. If it is done elsewhere, good ventilation should be provided. The volatile solvents can be dangerous: no naked flame must be in the room. A round-jet spray gun with a 0.8 mm nozzle is recommended for small areas. The spraying pressure should be of the order of 2 to 5 bar. The distance between component and spray gun should be such that the product is still moist when it strikes the surface. Tears or droplets should not occur. If the spray gun is held too far away from the component, the product will dry before reaching the surface. This will prevent the formation of a uniform Anti-Friction Coatings and the film will appear rough.

It is far more important to work with extreme care when applying Anti-Friction Coatings than when painting or varnishing, since an extremely thin but uniform film has to be produced. In order to produce a thicker film, several coats of Anti-Friction Coatings can be sprayed on. Each successive coat should, however, be applied to the previous coat when this is almost dry.

When spraying, use only compressed air that is free of water and oil. To apply the resin and the solid lubricant uniformly, the product must be stirred, especially after long breaks. In addition to spraying with compressed air, an electrostatic process may also be used. Before the coating hardens, sprayed parts must be handled with great care to prevent damages. Anti-Friction Coatings should dry in air for at least 10 minutes before being touched.

Dipping and centrifuging

If the shape and size of the parts permit, a dipping process can be used. Dip-spinning with a centrifuge is economical for applying Anti-Friction Coatings to large numbers of bulk goods like screws, nuts and small parts. Always dip-spin twice.

1. Dipping; centrifuging; spreading on wire grids; drying
2. Repetition of 1 to cover defects (contact points).

The required film thickness can be reached regulating the rotational speed of the centrifuge by the given viscosity of the Anti-Friction Coatings.

Surface pre-treatment of Anti-Friction Coatings (continued)

Washing, drying and impregnation of surface film

- Chromic acid process: rinse thoroughly in hot water (65°C); allow to air dry.
- Sulphuric acid process: wash parts thoroughly in water and seal coating in a 5% sodium dichromate or potassium dichromate solution by dipping. Rinse and allow to dry. The temperature during drying should not exceed 102°C. The component must not be touched with the bare hand thereafter.

Acid dip for copper and copper alloys instead of sandblasting

Copper and copper alloys are treated with a mixture of two or more of the following acids: sulphuric, phosphoric, chromic, nitric and hydrochloric acids. The mixing ratios and concentrations will vary greatly, depending on the alloy and surface conditions. Dipping times range from 5 seconds to 5 minutes. When pickling, take care that the basic metal is not attacked unnecessarily. When using nitric acid, toxic nitric oxide fumes must be removed by good ventilation. A quick-acting pickling bath can be used for flat components. For a large number of components or parts with complicated shapes, use a slow-acting bath. Follow any pickling with a thorough rinsing to remove any acid residue.

Pre-Treatment methods

	Steel	Galvanised parts	Aluminium alloy	Copper alloy	Magnesium alloy	Titanium alloy	High-grade steel
Pre-treatment							
Degreasing	x	x	x	x	x	x	x
Removal of oxides:							
- by pickling				x			x
- by sandblasting with aluminium oxide or cast-steel 55 µm	x		x	x		x	
Anodising to							
MIL-A-8625 C			x				
AMS 2488 (Ti-oxide Typ II)						x	
Bichromate treatment to MIL-M-3171 C					x		
Phosphating to DOD-P-16 232	x	x					
Oxalic acid treatment							x

Recommended pre-treatment methods for metal surfaces

Pre-treatment of plastic surfaces

With plastics too, surface pre-treatment increases the adhesion and service life of Anti-Friction Coatings. This is done primarily by degreasing and cleaning. Use only solvents that will not damage the substrate. Review relevant information supplied by the manufacturer of the plastic or plastic part. Adhesion can also be improved by roughening (e.g. fine sandblasting) or by activating the plastic surfaces in a low-pressure plasma. Before production starts, test the effectiveness of the chosen pre-treatment.

of Anti-Friction Coatings

Potential weaknesses

- High friction at low loads
- Running-in at high loads
- High coefficient of friction under humidity
- Dark grey colour only

- Lower service life at room temperature (when compared to MoS₂)
- Electrically conductive
- Black colour only

- Decomposition (+315°C)= toxic vapour
- Low load carrying capacity
- Not paintable

- Low load carrying capacity
- Limited temperature range

Strengths/Potential weaknesses of Technologies (continued)

2. Binders

Type	Chemical Resistance	Temp. Resistance	Air Curing
Epoxy	+++	+++	-
Polyamide	+++	+++	-
Phenolic	++	+++	-
Acrylic	++	++	+++
Titanate	-	++++	+++

3. Solvents

Type	Flash Point
Water	-
7414	+ 93 °C
L13	+ 27 °C

General differences to other types (in view of possibly replacing them)

Anti-Friction Coatings usually provide the following advantages compared to greases and pastes:

- Dry and clean lubrication, not affected by dust, dirt and humidity
- Lifetime lubrication in most cases
- Localized lubrication
- No aging, evaporation, oxidation
- Non flammable, dry film
- Can be applied in a film of controlled thickness
- Can often replace burnishing, hard chrome, lead plating, cadmium and galvanizing
- Fully effective even after prolonged shut down
- Vacuum and radiation resistant

Phosphating

Phosphating is suitable for pretreating iron and steel, not stainless steel, and for galvanised iron parts. Manganese phosphating increases the load carrying capacity of the coating. Zinc phosphating increases its corrosion protection. Only use phosphating baths which produce very fine crystalline layers. The process should produce a maximum dimensional deposition between 3 and 8 µm at the surface. This is equivalent to an increase in weight between 5 to 15 g/m².

The phosphate layer should have an even, uniform structure and its colour should range between grey and black. The components should not be speckled and, in particular, should exhibit neither specks of dried-on phosphating solution nor traces of corrosion. After treatment, parts should not be touched with bare hands.

Parts exhibiting a slightly irregular colour may be used. The Anti-Friction Coatings must be applied to the phosphated metal parts within 24 hours, otherwise corrosion may occur.

Oxalic acid treatment of stainless steel

Special oxalic acid baths are required because of the corrosion resistance of stainless steels. The operating instructions of the manufacturer concerned should be observed.

Sandblasting (after degreasing)

Sandblasting is recommended for parts made of steel, titanium, aluminium, copper, magnesium and their alloys. Aluminium oxide or cast-steel (grain size 55 µm) are most suitable for this purpose. It will produce an average surface roughness Ra between 0.5 and 1.0 µm. In most applications the dimensional change produced by sandblasting is of little significance, being less than 1.3 µm.

Remove adhering sand particles with dry, oil-free compressed air. To avoid corrosion, treated surfaces must not be touched with the bare hand and coated as soon as possible.

Anodic oxidation (anodizing) of aluminium and aluminium alloys

Aluminium and aluminium alloys should be pretreated by electrolytic oxidation. Alloys with a copper content of 0.5% or more or with a total content of alloying additions in excess of 7.5% must be treated in a sulphuric acid bath.

All other aluminium alloys and aluminium can be treated in a chromic acid bath. A chromic acid bath produces a thin surface film that ensures good corrosion protection. For a good surface film to develop, use water of high purity (low chloride and sulphate content) for all baths.

	Minimum weight of surface film	Thickness of coating
Chromic acid process	2,15 g/m ²	2,5 µm
Sulphuric acid process	6,50 g/m ²	5,0 µm

Surface pre-treatment of Anti-Friction Coatings

Pre-treatment of metal surfaces

The adhesion and service life of Anti-Friction Coatings are greatly affected by the surface pre-treatment of components.

Life of Anti-Friction Coatings

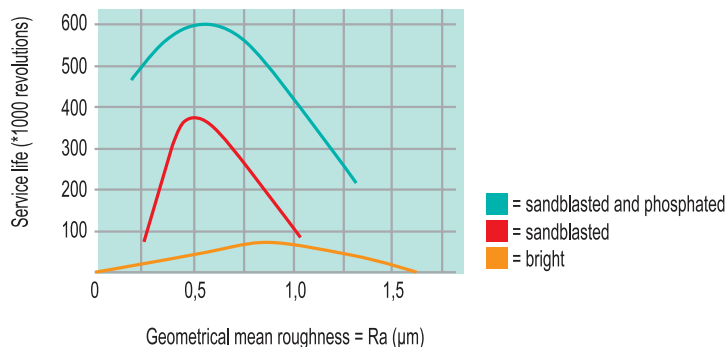

Effect of pre-treatment and surface roughness on the service life of Anti-Friction Coatings

Degreasing

In order to achieve a uniform surface pre-treatment and satisfactory application of Anti-Friction Coatings, the components must first be degreased carefully. Even when corrosion is removed with acid, a thorough degreasing is necessary to achieve an even wetting in the bath.

Degreasing is particularly successful using organic solvents or ultrasonic cleaners and wash plant with alkaline aqueous agents. Because of toxicological and safety concerns, however, consider to using organic solvents with very low-aromatic content.

If steam degreasing equipment is not available, remove oil and grease residues by washing in a suitable solvent. The solvent should leave no residue after evaporation, e.g. acetone or white spirit. Repeat the washing operation several times using fresh solvent each time.

Pre-treatment of corroded surfaces

Pretreat corroded surfaces by mechanical or chemical methods. As a mechanical method, sandblasting with aluminium oxide or with cast-steel (grain size 55 µm) is recommended. This produces an additional roughening of the component surface and provides better adhesion of the Anti-Friction Coatings. The acid and alkali treatments customary in electroplating are generally adequate. Baths should remove corrosion products but not unnecessarily attack the basic metal. Remove all traces of chemicals or solutions used in cleaning. Do not handle parts with bare hands.

Anti-Friction Coatings

Corrosion Resistance	Remarks
+++	High hardness, water-based feasible
++	Self lubricating/ difficult application
+	Water-based feasible
-	Water-based feasible
-	Limited film forming

Evaporation Curing Ranking	Remarks
8	Non toxic/ corrosion
7	Skin irritant
4	Smell

of lubricants

Potential limitations:

- Not recommended for high speed applications
- Under hydrodynamic conditions should only be used in combination with grease, oil, paste (they provide running-in aid and emergency lubrication)
- Comprehensive application process

Operating principles and conditions of Anti-Friction Coatings

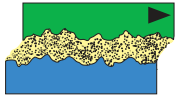

1. Hydrodynamic lubrication

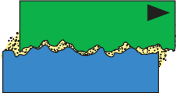

2. Boundary and mixed friction states

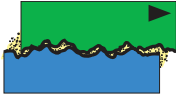

3. Mixed friction state plus Anti-Friction Coatings

Anti-Friction Coatings are particularly effective in frictional states of boundary friction and mixed friction as illustrated in the Stribeck diagram (see below). In these two conditions a fluid hydrodynamic lubrication can not be realized and direct metal-to-metal contact and wear take place; the solid lubricants are kept on the surface by the bonding force of the resin package; in this way the surfaces are always separated by an effective dry film, also in conditions of very low speeds, oscillating movements and high loads.

Anti-Friction Coatings can also effectively support hydrodynamic lubrication during running-in conditions and assuring emergency-running properties in case of break down of the hydrodynamic film.

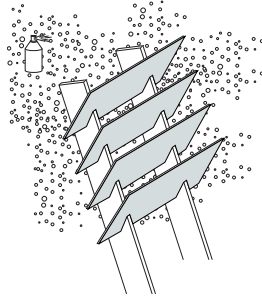
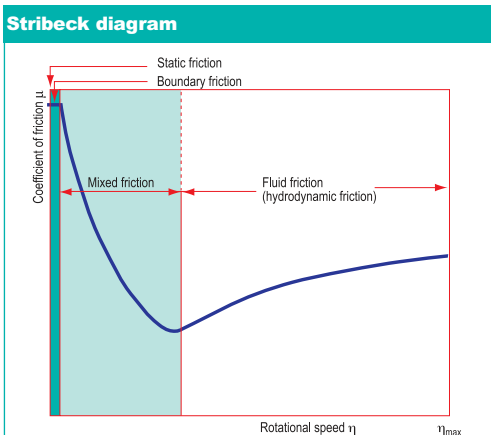

Salt spray test

- DIN 50021 – ASTM B 117
- Coated specimen or original parts are put in a chamber with salt water spray
- Test criteria: rust formation
- Measured properties: corrosion resistance

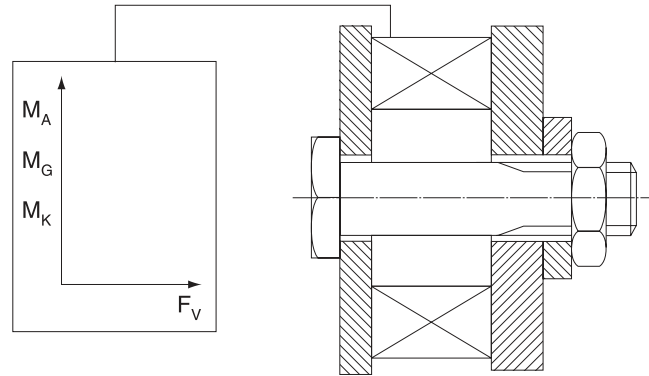

Erichsen Test Machine

- Test equipment to measure the coefficient of friction on bolted connections at room temperature
- Type of contact: area (thread and underhead)
- Type of friction: sliding friction
- Test criteria: pretensioning force, tightening torque
- Measured properties: coefficient of friction on thread and underhead

All these test equipments are currently in operation at our technical centres. Furthermore our test fields are equipped with special test machines based on original automotive or industrial machine elements to evaluate the tribological behaviours under different environmental conditions.

Based also on these capabilities we are confident to be able to offer to our customers the best solution to solve their dry lubrication problems.

Typical testing methods for Anti-Friction Coatings

The performance characteristics of Anti-Friction Coatings can be evaluated on standard test machines which can simulate the different tribological contacts; by changing the different testing parameters the performance of the lubricant on several machine elements can be simulated. Sketches and description of the operating principles of the machines are reported here.

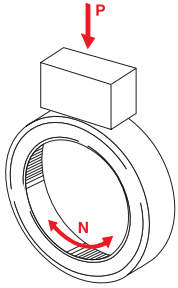

Falex LFW1 (Block on Ring Test Machine)

- ASTM D 2714
- A stationary block is loaded against a rotating or oscillating ring
- Type of contact: line or area
- Type of friction: sliding friction
- Test criteria: friction force, sliding distance, number of oscillations/revolutions
- Measured properties: endurance life, friction value, load carrying capacity

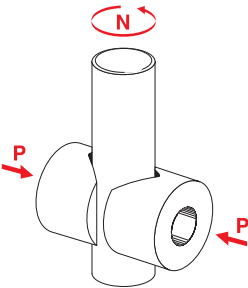

Falex Pin and Vee Test Machine

- ASTM D 2625
- Two stationary vee blocks are loaded against a rotating pin specimen
- Type of contact: 4 lines
- Type of friction: sliding friction
- Test criteria: weld load, friction torque
- Measured properties: extreme pressure, load carrying capacity, endurance life

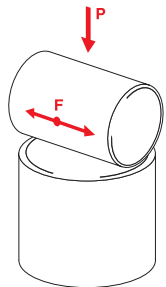

SRV Test Machine

- DIN 51834
- A translatable oscillating ball or cylinder is loaded against a fixed flat disc specimen
- Type of contact: point (ball) or line (cylinder)
- Type of friction: sliding friction
- Test criteria: weld load, friction force, number of oscillations
- Measured properties: load carrying capacity, endurance life, friction value



SEM photograph with 1000x magnification: MoS₂ Anti-Friction Coatings before (left) and after (right) load application

Applied Anti-Friction Coatings contain up to 70% solid lubricants. Solid lubricants with a lamellar structure like MoS₂ exhibit a floating effect in a wet film, whereby, as the film dries, they orient themselves horizontally and are deposited as individual layers. Under load, the structure of the film is further compacted producing an extremely smooth film surface covering the asperities of the carrier material.

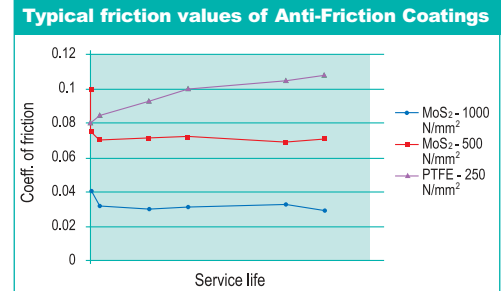

Typical friction values of MoS₂ and PTFE based Anti-Friction Coatings under different loads.

(Values measured with the LFW1 test machine - ASTM-D-2714 method)

"In the diagram the typical running-in effect of MoS₂ based, Anti-Friction Coatings can be noticed"

Strengths/Potential weaknesses compared to

ponents

Lubricant	MoS ₂ AFC	PTFE AFC	Unsteady coefficient of friction	Short lubrication intervals	Contamination, chalking	Unsatisfactory surface quality	Short service life because of extreme temperatures	Lubrication failure because of chemical attack	Environmental application problems	Corrosion
Mineral-Oil grease	Sealing	Sealing								
	Noise reduction	Noise reduction								
	Load carrying	Temp. range	7405	D 3484	7405	D 321R	D 321R	7409	7400	3400A
	Temp. range	Adhesion	PTFE-N UV	3400A	7409	D 3484	7409	3400A	D 106	Leadfree
	Adhesion	Fretting corrosion		Leadfree	D 708	3400A	3400A	Leadfree		7409
	Fretting corrosion	Solid state friction				Leadfree	Leadfree	D 708		D 708
	Solid state friction	Chem. resistance						D 10		
	Chem. resistance	Separating effect								
Corrosion protection	Colourless									
	Corrosion protection		7405	106	7405	D 321R	3400A		7400	7409
Synthetic grease	Sealing	Sealing			7409	106	Leadfree		D 106	3400A
	Noise reduction	Noise reduction			D 708		D 321R			Leadfree
	Plastics compatibility						7409			D 708
	Load carrying	(Temp. range)								
	Temp. range	Adhesion								
	Adhesion	Fretting corrosion								
	Fretting corrosion	Solid state friction	7405	106	7405	D 321R	3400A	3400A	7400	7409
	Solid state friction	(Chem. resistance)			7409	106	Leadfree	Leadfree	D 106	3400A
(Chem. resistance)	Separating effect					D 321R	7409		Leadfree	
Corrosion protection	Colourless					7409			D 708	
	Corrosion protection									
Silicone grease	Sealing	Sealing								
	Noise reduction	Noise reduction	D 321R	3400A	7409	D 321R	D 321R	7409	7400	7409
	Plastics compatibility		106	Leadfree		D 106	7409	3400A	D 106	3400A
	Load carrying	Load carrying	7405	106			3400A	Leadfree		Leadfree
	Temp. range	(Temp. range)		D 3484			Leadfree			D 708
	Adhesion	Adhesion								
	Fretting corrosion	Fretting corrosion								
	Solid state friction	Solid state friction								
Lower friction coeff.	Lower friction coeff. (Colourless)	7409	D 321R	7409	D 321R	D 321R	D 321R		7409	
	Corrosion protection						7409			
MoS ₂ -paste	Corrosion protection	Corrosion protection								
	Adhesion	Adhesion	7409	7409	7409	3402-C	7409	7409		3400A
		Separating effect	D 708	3400A			3400A	D 708		Leadfree
	Colour		Leadfree			Leadfree			7409	D 708
Grease paste	Sealing	Sealing								
	Noise reduction	Noise reduction								
	Load carrying	Corrosion protection								
	Corrosion protection	Adhesion	7409	7409	7409	3400A	7409	7409	7409	7409
	Adhesion	Separating effect				Leadfree				
	Colourless									
			7405		7405	7405	D 321R	7405	7400	7405
			D 708		D 708		D 708	7405	7405	D 708
Thread paste	Sealing	Sealing								
	Easy application	Easy application								
	Adhesion	Adhesion								
	Corrosion protection	Corrosion protection	PTFE-N UV	D 96		D 96			D 96	
		Separating effect	D 96							
	Colourless									
			3402-C	3402-C	7409	D 321R	D 321R	7409	D 321R	7409
			7409	3400A		3402-C	3400A	3400A		3400A
				Leadfree			Leadfree	Leadfree		Leadfree
				7409			7409			
			7409	7409		3400A	7409	7409	7400	D 10
				D 10		Leadfree		D 10	7409	7409
				D 88				D 88	D 10	D 88

■ = Strengths of Anti-Friction Coatings □ = Strengths of other lubricants

MOLYKOTE® Anti-Friction Coatings solutions for machine com

Solutions for	Running-in damages	Scuffing, scoring, seizure	High wear, pitting	Short service life because of high loads	Fretting corrosion	Stick-slip
Machine components						
Hinges, springs, locks, switches, bolts, safety belts, ski-bindings	D 321R	3400A Leadfree D 3484 7409 3402-C D 106	3400A Leadfree 7409 106	D 3484 3400A Leadfree D 106	106 7409	3400A Leadfree D 3484 7409 D 106
Brake parts, clutches, solenoids	D 321R 7400	D 106 7409 3400A Leadfree	D 106 7409	3400A Leadfree D 106 7409	106	D 106 7405 7409
Sleeve bearings, chain elements, self-aligning bearings, sintered metal bushings, bearings	D 321R	106 3400A Leadfree	106 7409	3400A Leadfree D 106 7409	106	D 321R 7409
Slides, spindles, bed ways, adjusting wedges, gear racks	D 321R	D 321R 106 D 106	3400A Leadfree 106 7409 D 106	D 321R 106 D 106	106	D 321R 106 D 106
Reactor parts lubrication	D 321R	D 321R	D 321R 7409	D 321R	7409	D 321R
Weapons, ammunition	3402-C	3402-C 7409 3400A Leadfree	3402-C 3400A Leadfree	3402-C 3400A Leadfree	3400A Leadfree 3402-C 7409	3402-C 3400A Leadfree D 708
Valves, carburettors, pumps	7409	7409	7409	7409	7409	7409
Nuts and bolts		D 708 7405		3402-C	3402-C	D 708 7405
Elastomer seals/profiles, plastic parts	D 96			D 96		D 96
Aircrafts, rockets, helicopters, space stations	D 321R	7409 3402-C	7409 3400A Leadfree 3402-C	3400A Leadfree 3402-C 7409	106 7409	3400A Leadfree 3402-C D 321 R
Pistons, hydraulic parts, cam shafts, gears	D 10 D 88 7409 7400	D 10 7409 D 88	7409 D 10 D 88	7409	7409	7409

other lubricant types

Graphite AFC	Synth. AFC
Sealing	Sealing
Noise reduction	Noise reduction
Load carrying	Load carrying
Temp. range	Temp. range
Adhesion	Adhesion
Fretting corrosion	Fretting corrosion
Solid state friction	Solid state friction
Chem. resistance	Chem. resistance
Oil resistance	Separating effect
Solvent resistance	Colour
Sealing	Sealing
Noise reduction	Noise reduction
Plastics compatibility	
Load carrying	Load carrying
Temp. range	(Temp. range)
Adhesion	Adhesion
Fretting corrosion	Fretting corrosion
Solid state friction	Solid state friction
(Chem. resistance)	(Chem. resistance)
(Oil resistance)	Separating effect
(Solvent resistance)	Colour
Sealing	Sealing
Noise reduction	Noise reduction
Plastics compatibility	Plastics compatibility
Load carrying	Load carrying
Temp. range	Adhesion
Adhesion	Fretting corrosion
Fretting corrosion	Solid state friction
Solid state friction	Lower friction coeff.
(Chem. resistance)	Corrosion protection
(Oil resistance)	Colour
(Solvent resistance)	
Corrosion protection	Corrosion protection
Adhesion	Adhesion
	Separating effect
	Colour
Sealing	Sealing
Noise reduction	Noise reduction
Load carrying	Load carrying
Corrosion protection	Corrosion protection
Adhesion	Adhesion
Separating effect	Separating effect
Oil resistance	Colour
Solvent resistance	
Sealing	Sealing
Easy application	Easy application
Adhesion	Adhesion
Corrosion protection	Corrosion protection
Separating effect	Colourless
Oil resistance	Very low coeff. of friction
Solvent resistance	

Strengths comparison among PTFE and Synthetics-

PTFE-N UV	PTFE-N UV	D 708	Endurance life (LFW- 1 test, ASTM- D- 2714)		Fretting corrosion resistance (Deyber test) [oscillations]	Typical corrosion protection values (*) (ISO R 1456) [h]	Curing schedule [min/°C]	Flash point [°C]	Surface coverage m/kg
			[Revolutions in thousands]	[Oscillations in thousands]					
PTFE-N UV	Colourless								
	Air drying								
	Aerosol								
	Load carrying capacity		s=480	s=210	14x10 ⁶	-	5/20	+23	7
	Chemical resistance								
	Corrosion protection								
	Adhesion								
D 708	Load carrying capacity		s=150	s=15	5x10 ⁶	p+sp=120	120/20	+12	15
	Chemical resistance		p=300	p=350	28x10 ⁶	p+sp=24	10/170	+23	10
	Corrosion protection								
	Adhesion		p=100	p= > 50	7x10 ⁶	p+sp=500 p+dp=240	30/200	< +21	15
	Colourless								
	Air drying		p=380	p=280	24x10 ⁶	-	60/150	+24	15
	Aerosol		p=350	p=100	> 36x10 ⁶	p+sp=300 p+dp=96	30/220	+28	12
D 96	Water-based	Colourless	p=400	p=100	> 36x10 ⁶	p+sp=300	20/220	+28	14
	Low friction	Air drying							
		Water-based	p=200	p=100	9x10 ⁶	-	40/20	None	16
	Temperature resistance	Temperature resistance	p=300	p=180	24x10 ⁶	p+sp=24	60/200	+84	15
	Adhesion	Load carrying capacity	p=15	p=36	20x10 ⁶	p+sp=24	120/20	-19	18
	Aerosol	Chemical resistance							
		Corrosion protection	p=9	p=13	1x10 ⁶	p+sp=500 p+dp=360	20/200	0	18
		Adhesion							
7405	Load carrying capacity	Low friction	-	-	-	-	120/20	> +100	-
	Low friction	Higher flash point				p+sp=200			
	Chemical resistance								
	Corrosion protection		p=150	p=100	> 36x10 ⁶	p+dp=96	60/120	+41	16
	Colourless								
	Air drying	Chemical resistance	p=6	p=1	> 36x10 ⁶	-	30/180	+63	8
	Aerosol	Corrosion protection				p+sp=300 p+dp=120	20/210	+63	-

■ = strengths of the Anti-Friction Coatings in the row compared to the Anti-Friction Coatings in the column

□ = strengths of the Anti-Friction Coatings in the column compared to the Anti-Friction Coatings in the row

(*): as the performance in corrosion resistance is affected by the geometry of the parts coated, by the pre-treatment of the surface, by the application method and by the thickness of the applied dry film, these values should be considered typical.

Typical properties of MOLYKOTE® Anti-Friction Coatings based Anti-Friction Coatings

MOLYKOTE® Product	Solid Lubricant	Thinner - compatible solvent	Colour	Service temperature range [°C]	Load carrying capacity (Falex test, ASTM-D-2625) [N]	D 96		7405	
						Temperature resistance	Adhesion	Colourless	Air drying
D 321R	MoS ₂	L 13	grey	-180/+450	15.000	Aerosol	Water-based	Low friction	Chemical resistance
3402-C	MoS ₂	L 13	grey	-200/+315	15.500	Water-based	Low friction	Chemical resistance	Corrosion protection
D 3484	MoS ₂	L 13	grey	-70/+250	15.500	Low friction	Chemical resistance	Corrosion protection	
3400A Leadfree	MoS ₂	L 13	grey	-200/+430	20.000	Adhesion	Chemical resistance	Corrosion protection	
106	MoS ₂	L 13	grey	-70/+250	15.500	Colourless	Air drying	Water-based	
7409	MoS ₂	7414	grey	-70/+380	15.800	Water-based	Colourless	Air drying	Higher flash point
7620	MoS ₂	7414	grey	-70/+380	15.800		Air drying	Water-based	
7400	MoS ₂	water	grey	-70/+200	13.000		Water-based	Temperature resistance	
D 106	MoS ₂	water	grey	-70/+250	13.500		Temperature resistance	Load carrying capacity	Chemical resistance
PTFE-N UV	PTFE	L 13	transparent	-180/+240	4.000		Load carrying capacity	Chemical resistance	Corrosion protection
D 708	PTFE	L 13	black	-180/+240	1.220		Chemical resistance	Corrosion protection	Adhesion
D 96	PTFE	water	transparent	-40/80	-		Adhesion	Colourless	
7405	Synt.	7414	yellowish transparent	-70/+200	15.000		Temperature resistance	Load carrying capacity	Chemical resistance
D 10	Graphite	7414	black	-70/+380	13.600		Corrosion protection	Adhesion	
D 88	Special	7414	silver-grey	-70/380	-		Colourless	Air drying	Water-based

dp= application by dip-spinning – sp= application by spraying
p= phosphated surface – s= sandblasted surface

Strengths comparison among MoS₂ based Anti-Friction Coatings

	D 321R	D 3484	3400A Leadfree	3402-C	106	7409/7620	D 106	7400
D 321R		Temp. resistance Extreme load Aerosol Air curing	Low friction Air drying Aerosol Higher flash point	Temp. resistance Low friction Aerosol Higher flash point Non toxic	Temp. resistance Good adhesion Air drying Aerosol	Air drying Aerosol	Temp. resistance Air drying Aerosol	Temp. resistance Good adhesion Aerosol
		No chalking Chem. resistance Corr. protection	No chalking Corr. protection Chem. resistance	Corr. protection No chalking MIL-spec.	Chem. resistance No chalking	Chem. resistance Corr. protection No chalking	Corr. protection No chalking Water-based	Water-based No flash point
D 3484	No chalking Chem. resist. Corr. protection Temp. resistance Extreme load Aerosol Air curing		Low friction Fast curing Higher flash point Temp. resistance Corr. protection	Low friction Higher flash point Non toxic Temp. resistance Air drying MIL-spec.	Low friction Corr. protection Fast curing MIL-spec.	Fast curing Temp. resistance Chem. resistance Corr. protection	Low friction Fast curing Water-based	Temp. resistance Corr. protection Air drying Water-based No flash point
3400A Leadfree	Corr. protection Chem. resistance No chalking Low friction Air drying Aerosol Higher flash point	Temp. resistance Corr. protection		Temp. resistance Corr. protection Air drying	Temp. resistance Corr. protection	Temp. resistance Corr. protection Low friction Lower curing temp Higher flash point	Temp. resistance Chem. resistance Corr. protection Low friction Water-based	Temp. resistance Chem. resistance Corr. protection Low friction Air drying Water-based No flash point
3402-C	No chalking Corr. protection MIL-spec. Temp. resistance Low friction Aerosol Higher flash point Non toxic	Temp. resistance Air drying MIL-spec. Low friction Higher flash point Non toxic	Air drying Temp. resistance Corr. protection	Temp. resistance Corr. protection MIL-spec. Low friction Higher flash point Non toxic	Temp. resistance Corr. protection Air drying MIL-spec. Low friction Higher flash point Non toxic	Air drying MIL-spec. Temp. resistance Low friction Chem. resistance Corr. protection Higher flash point Non toxic	Temp. resistance Air drying MIL-spec. Low friction Water-based Non toxic	Temp. resistance Chem. resistance Corr. protection MIL-spec. Low friction Water-based No flash point Non toxic
106	Chem. resistance No chalking Temp. resistance Good adhesion Air drying Aerosol	MIL-spec. Low friction Corr. protection Fast curing	Low friction Lower curing temp. Higher flash point Temp. resistance Corr. protection	Low friction Higher flash point Non toxic Temp. resistance Corr. protection Air drying MIL-spec.	Temp. resistance Chem. resistance Corr. protection	Lower curing temp. MIL-spec. Temp. resistance Chem. resistance Corr. protection	Storage stability Lower curing temp. MIL-spec. Corr. protection Water-based	Temp. resistance Chem. resistance MIL-spec. Air drying Water-based No flash point
7409 / 7620	Chem. resistance Corr. protection No chalking Air drying Aerosol	Temp. resistance Chem. resistance Corr. protection Fast curing	Low friction Chem. resistance Higher flash point Temp. resistance Corr. protection	Temp. resistance Low friction Chem. resistance Corr. protection Higher flash point Non toxic Air drying MIL-spec.	Temp. resistance Chem. resistance Corr. protection	Temp. resistance Chem. resistance Corr. protection Storage stability Water-based	Temp. resistance Chem. resistance Corr. protection Storage stability	Temp. resistance Chem. resistance Corr. protection Air drying Water-based No flash point
D 106	Corr. protection No chalking Water-based Temp. resistance Air drying Aerosol	Water-based Low friction Fast curing	Low friction Water-based Temp. resistance Chem. resistance Corr. protection	Low friction Water-based Non toxic Temp. resistance Air drying MIL-spec.	Corr. protection Water-based Storage stability Lower curing temp. MIL-spec.	Water-based Temp. resistance Chem. resistance Corr. protection Storage stability	Temp. resistance Corr. protection Chem. resistance No flash point	Temp. resistance Corr. protection Chem. resistance Air drying No flash point
7400	Water-based No flash point Temp. resistance Good adhesion Aerosol	Air drying Water-based No flash point Temp. resistance Corr. protection	Low friction Air drying Water-based No flash point Temp. resistance Chem. resistance Corr. protection	Low friction Water-based No flash point Non toxic Temp. resistance Chem. resistance Corr. protection MIL-spec.	Air drying Water-based No flash point Temp. resistance Chem. resistance MIL-spec.	Air drying Water-based No flash point Temp. resistance Chem. resistance Corr. protection	Air drying No flash point Temp. resistance Corr. protection Chem. resistance	Temp. resistance Good adhesion Aerosol

■ = strengths of the Anti-Friction Coatings in the row compared to Anti-Friction Coatings in the column

□ = strengths of the Anti-Friction Coatings in the column compared to Anti-Friction Coatings in the row

Welcome to the
MOLYKOTE®
Anti-Friction Coatings
Selection Guide
from Dow Corning.
In the following pages,
you will find a complete
overview of the Molykote
Anti-Friction Coatings
product range.
It includes a variety of
technical information
that you will find helpful
when selecting the
right product for your
specific application.
If you cannot find
the specific information
you need, please
contact your Molykote
representative.

Page

- 4** MOLYKOTE® Anti-Friction Coatings

- 6** Strengths/Potential weaknesses of Anti-Friction Coatings Technologies

- 8** Strengths/Potential weaknesses of Anti-Friction Coatings Technologies (continued)

- 8** General differences to other types of lubricants

- 10** Operating principle and conditions of Anti-Friction Coatings

- 12** Strengths/Potential weaknesses compared to other lubricant types

- 14** Strengths comparison among PTFE and Synthetics-based Anti-Friction Coatings

- 16** Strengths comparison among MoS₂ based Anti-Friction Coatings

- 18** Typical properties of Molykote® Anti-Friction Coatings

- 20** MOLYKOTE® Anti-Friction Coatings solutions for machine components

- 22** Typical testing methods for Anti-Friction Coatings

- 24** Surface pre-treatment of Anti-Friction Coatings

- 26** Surface pre-treatment of Anti-Friction Coatings (continued)

- 27** Application of Anti-Friction Coatings

- 28** Application of Anti-Friction Coatings (continued)

- 30** Application engineering + Application examples of Anti-Friction Coatings

Application examples



AV01643



AV5898



AV05999



AV05998



AV05991



MOLYKOTE®

FROM DOW CORNING

**High Performance Industrial Lubricants
Application Selector Guide**



AV07061

Pastes • Greases • Compounds • Oils • Coatings • Dispersions

Rolling Element Bearings



Application	Substrates	Temperature Range [°C]	Other Considerations	Molykote® Solution
Assembly/ Pre-treatment	Metal to metal	-25 to +250	Prevention of fretting corrosion	TP-42
Operation	Metal to metal	-30 to +130	General purpose/high loads	BR2 Plus
		-45 to +180	Synthetic/combinations of high load, temperature high speed (to 600.000 DN)	BG-20
		-40 to +150	Extreme high speeds/long life/low noise	BG-555
		+10 to +160	Water wash-out resistance/low speed	1122
		-30 to +150	"Clean" white/food grade grease in NLGI #0, 1 or 2	G-0050FG, G-0051FG, G-0052FG
		-40 to +150	Multi-purpose synthetic/food grade	G-4500, G-4501
		-40 to +177	Synthetic lubrication/moderate to high loads	G-4700
		-73 to +180	Wide temperature range	33 Light, 33 Medium
		-20 to +290	Extreme high temperatures	41
		-40 to +200	High temperatures	44 Light, 44 Medium
		-40 to +230	Solvent resistance/high load/high temperature/NLGI #2	3451
		-65 to +250	High temperature/chemical resistant	HP-300
Storage protection	Metal components		Corrosion protection/dry film	Metal Protector Plus

Press Fit Joints



Application	Substrates	Temperature Range [°C]	Other Considerations	Molykote® Solution
Assembly	Metal to metal	-35 to +450	Very low coefficient of friction	G-Rapid Plus
		-25 to +450	Medium coefficient of friction	G-n Plus
		-25 to +250	White product	D
		-30 to +300	White/food grade	P-1900

Maintenance

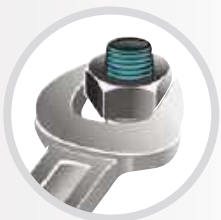

Application	Substrates	Temperature Range [°C]	Other Considerations	Molykote® Solution
Assembly of threaded connections	Metal to metal	-30 to +650	General purpose	1000
		-30 to +300	White/food grade	P-1900
			Consistent assembly torque	1000
		Aluminum or stainless steel	-40 to +1400	No corroding/extreme temperature/sulphur and metal-free
Press fitting	Metal to metal	-35 to +450	Very low coefficient of friction	G-Rapid Plus
		-25 to +450	Medium coefficient of friction	G-n Plus
		-25 to +250	White product	D
		-30 to +300	White/food grade	P-1900
Disassembly	Metal to metal	-50 to +50	Loosen rusted parts	Multigliss, Supergliss
Corrosion protection	Metal to metal	-30 to +300	Corrosive environment	Cu-7439 Plus
Storage: Corrosion protection	Metal to metal		Long stocking intervals	Metal Protector Plus
Oiled machine components	Metal to metal	Depends on oil to which it is added	High loads	A, M-55 Plus
Sticking of rubber, metal and plastic parts	Metal to plastic to rubber	-40 to +200	Silicone release agent	Separator Spray

Linear Motion Guides

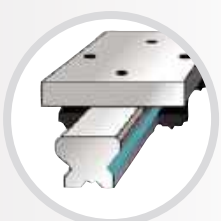

Application	Substrates	Temperature Range [°C]	Other Considerations	Molykote® Solution
Operation	Metal to metal	-25 to +120	General purpose lubricant	Multilub
		-25 to +110	High loads	Longterm 2 Plus
		-40 to +180	High temperatures	BG-20
Pre-treatment		-65 to +175	High wear due to intermittent operation	3402C

Chain Drives

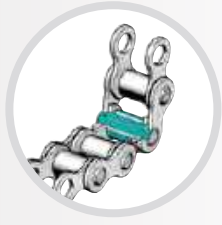

Application	Substrates	Temperature Range [°C]	Other Considerations	Molykote® Solution
Greased chains	Metal to metal	+10 to +160	Water wash-out resistant/high speeds	1122
		-25 to +150	High speeds/good penetration	MKL-N
		-40 to +230	Tacky paste/wide temperature range/water-resistant	P-40
		-180 to +450	Long-term lubrication	D-321 R
Oiled chains	Metal to metal		High-temperature chains/MoS ₂ content	M-30
			Extreme loads/high MoS ₂ content	M-55 Plus
		-10 to +200	High temperature/low volatility/no odor	L-1428
		-50 to +120	Wide temperature range/PAO/food grade/tacky	L-1468FG
			Corrosion protection/dry film	Metal Protector Plus

Threaded Connections

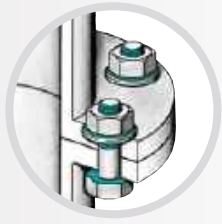

Application	Substrates	Temperature Range [°C]	Other Considerations	Molykote® Solution
Pre-assembly	Metal to metal	-30 to +650	High temperature/no scattering of assembly torque	1000
		-30 to +1100	High temperature/general purposes/contains no lead or nickel	HSC Plus
		-25 to +250	White product	D
		-30 to +300	White/food grade	P-1900
		-40 to +1500	Very high temperature/compatible to a wide range of high temperature steels	P-74
	Aluminum or stainless steel	-40 to +1400	No corroding/extreme temperature sulfur and metal-free	P-37
Disassembly	Metal to metal		Loosen rusted parts	Multigliss
Storage Protection	Metal components		Corrosion protection/dry film	Metal Protector Plus

Power Screw Drives



Application	Substrates	Temperature Range [°C]	Other Considerations	Molykote® Solution		
Operation	Metal to metal	-30 to +130	General purpose	Multilub		
		-30 to +130	General purpose	BR-2 Plus		
		-40 to +150	Multi-purpose synthetic/food grade	G-4500		
		-180 to +450	Dusty environments/extreme pressure	D-321 R		
			Plastic to metal/plastic to plastic	-73 to +180	Wide temperature range/long life	33 Light, 33 Medium
				-40 to +150	Multi-purpose synthetic/food grade	G-4500
		-40 to +230	Chemical resistance	3451		

Control Cables



Application	Substrates	Temperature Range [°C]	Other Considerations	Molykote® Solution		
Operation		-40 to +130	General purpose semi-synthetic	PG-75		
		-73 to +180	Wide temperature range/low friction	33 Light, 33 Medium		
			Metal wire/cable too metal liner	-180 to +450	Dusty environments/low friction	D-321 R
				-40 to +150	Multi-purpose synthetic/food grade	G-4500
Storage Protection	Metal components		Corrosion protection/dry film	Metal Protector Plus		

Slides, Guides & Tracks

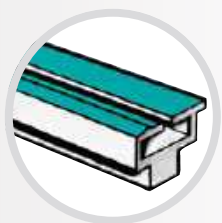

Application	Substrates	Temperature Range [°C]	Other Considerations	Molykote® Solution
Operation	Metal to metal	-30 to +150	"Clean" white grease/food grade	G-0052FG
		-30 to +300	"Clean" white paste/food grade	P-1900
		-30 to +650	High temperatures	1000
		-25 to +450	High loads	G-n Plus
		-40 to +150	Multi-purpose synthetic/moderate loads/food grade	G-4500
		-40 to +177	Synthetic lubrication/high loads	G-4700
		-180 to +450	Dusty environments	D-321 R
			Aluminum surfaces/nonstaining	
	Plastic to plastic/metal	-40 to +150	Multi-purpose synthetic/food grade	G-4500, G-4501
		-73 to +180	Wide temperature range/long life	33 Light, 33 Medium
Storage Protection	Metal components		Corrosion protection/dry film	Metal Protector Plus

Gears

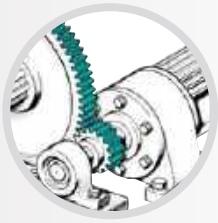

Application	Substrates	Temperature Range [°C]	Other Considerations	Molykote® Solution
Pretreatment	Metal to metal	-25 to +450	Run-in lubricant	G-Rapid Plus
Operation	Metal to metal	-40 to +150	Multi-purpose synthetic/food grade	G-4500
		-40 to +177	Synthetic lubrication/high loads	G-4700
		+10 to +160	Tacky grease	1122
		-40 to +230	Tacky paste/wide temperature range/ water-resistant	P-40
		-180 to +450	Dusty environments	D-321 R
		-70 to +250	Heat-cure bonded	106
		-40 to +130	Multi-purpose semi-synthetic	PG-75
		-45 to +150	Multi-purpose synthetic/high loads/ fiber reinforced	EM-30L
		-45 to +150	Multi-purpose synthetic/high loads/ good adhesion	YM-103
		-73 to +180	Wide temperature range/low friction	33 Light, 33 Medium
-35 to +250	Very high temperatures/very good compatibility/resistant to chemicals	HP-870		
In Gear Boxes	Metal to metal		Extreme loads/reduce energy	M-55 Plus
			Heavily loaded, slow speed/ AW/EP additives	L-21xx
			Excellent AW properties/bronze friendly	L-11xx
			Synthetic/food grade	L-11xxFG
			Mineral oil/food grade	L-01xxFG
Storage Protection	Metal components		Corrosion protection/dry film	Metal Protector Plus

Plain Bearings, Bushings & Sleeves



Application	Substrates	Temperature Range [°C]	Other Considerations	Molykote® Solution
Pretreatment	Metal to metal	-25 to +450	Run-in lubricant	G-Rapid Plus
		-70 to +200	Solventless run-in coating	7400
		-180 to +450	Dusty environments	D-321 R
Operation	Metal to metal	-30 to +130	General purpose	BR-2 Plus
		-45 to +180	General purpose synthetic	BG-20
		-30 to +150	"Clean" white grease/food grade	G-0052FG
		-40 to +230	Tacky paste/wide temperature range/water-resistant	P-40
		-25 to +250	"Clean" white paste/food grade	P-1900
		-25 to +250	Prevention of fretting corrosion	TP-42
		-40 to +150	Multi-purpose synthetic/ food grade	G-4500
		-40 to +177	Synthetic lubrication/high loads	G-4700
		-40 to +230	Chemical/solvent resistance	3451
		-40 to +130	Multi-purpose semi-synthetic	PG-75
		-50 to +140	Multi-purpose synthetic	G-2003
		-45 to +130	Multi-purpose synthetic/ high loads/fiber reinforced	EM-30L
		-45 to +150	Multi-purpose synthetic/ high loads/good adhesion	YM-103
		-73 to +180	Wide temperature range	33 Light, 33 Medium
		-40 to +230	Solvent resistance	3451
		-40 to +200	Wash-out resistance/low speeds	111 Compound
-35 to +250	Very high temperatures/ very good compatibility/ resistant to chemicals	HP-870		
Storage Protection	Metal components		Corrosion protection/dry film	Metal Protector Plus

Pastes

Grease-like materials containing a very high percentage of solid lubricants. Used for assembly and lubrication of highly loaded, slow moving parts for threaded fasteners.

1000
Cu-7439 Plus
D
DX
E
G-n Plus

Molykote® Solution

G-Rapid Plus
HSC plus
HTP
M-77
P-37
P-40

P-74
P-1600
P-1900
TP-42
U-n
X

Greases

Solid to semisolid materials consisting of a lubricating fluid, thickening agent and additives. Used on rolling element bearings and other moving parts.

41
33 Light
33 Medium
44 Light
44 Medium
55 O-Ring
165 LT
822M
1102
1122
1292
3451
3452
7348
7514
BG-20
BG-555
BR2 Plus

Molykote® Solution

EM-30L
EM-50L
EM-60L
FB 180
G-67
G-68
G-72
G-807
G-0050FG
G-0051FG
G-0052FG
G-0100
G-0101
G-0102
G-1001
G-2001
G-2003

G-4500
G-4501
G-4700
High Vacuum Grease
HP-300
HP-870
Longterm 00
Longterm 2 plus
Longterm W2
Multilub
PG-21
PG-54
PG-65 Plastislip
PG-75
X5-6020
YM-102
YM-103

Compounds

Grease-like materials composed of silicone fluids and silica fillers. Used for their sealing, dielectric, non-metal-to-metal lubricating and release properties.

Molykote® Solution

111 Compound
Dow Corning® 4
Dow Corning® 7
Dow Corning® 340

High-Performance Industrial Lubricating Oils

Based on hydroprocessed mineral oils or synthetic base stocks such as polyalphaolefin (PAO) and esters, these lubricating fluids are fortified with carefully selected additives to provide optimum performance and service life while maximizing protection of the equipment and machinery they are designed to lubricate.

Molykote® Solution

Chain Oils
Compressor and Vacuum Pump Oils
Gearbox Oils
Hydraulic Oils and Multi-purpose Oils
Special Purpose Oils

Coatings

"Lubricating paints"; when applied, these materials cure to form dry, solid lubricant coatings that are bonded to the surface.

106
3400A Leadfree
3402C
7400
7405

Molykote® Solution

7409
D 10
D-321 R
D-3484
D-708

D-96
L-0500
Metal Protector Plus
PTFE-N UV
S-1010

Dispersions

Finely divided solid lubricants suspended in lubricating fluids; preferred when it is necessary to apply solid lubricants in liquid form.

Molykote® Solution

A
HTF
M-30
M-55 Plus

MKL-N
Multigliss
OmniGliss
W15

* For more information on the product and service offering in your area, please contact our sales representative or one of our offices listed in this brochure.

How To Contact Us

For nearly 60 years, OEM designers, maintenance and materials engineers around the world have trusted the Molykote® brand for performance and expertise to solve or prevent lubrication problems. Molykote solutions are available through a distributor network of more than 3,000 channel partners around the globe. To learn more about our extensive product and service offering, visit www.molykote.com or email industrial@dowcorning.com.

Japan

Dow Corning Toray Co., Ltd.
Phone: +81 3287 8300

Australia

Dow Corning Australia Pty Ltd.
Phone: +61 2 9888 4351

China

Dow Corning (Shanghai) Company, Limited
Phone: +86 21 2306 5500

India

Dow Corning India Private Limited
Phone: +91 22 6694 6868

Korea

Dow Corning Korea Ltd.
Phone: +82 2 551 7600

Singapore

Dow Corning Singapore Pte Ltd
Phone: +65 6253 6611

Thailand

Dow Corning (Thailand) Ltd.
Phone: +662 634 7078

North American and Corporate Headquarters

Dow Corning Corporation
Phone: +1 989 496 4000

European Area

Dow Corning GmbH
Phone: +49 611 2371

LIMITED WARRANTY INFORMATION — PLEASE READ CAREFULLY

The information contained herein is offered in good faith and is believed to be accurate. However, because conditions and methods of use of our products are beyond our control, this information should not be used in substitution for customer's tests to ensure that Dow Corning's products are safe, effective, and fully satisfactory for the intended use. Suggestions of uses should not be taken as inducements to infringe any particular patent.

Dow Corning's sole warranty is that the product will meet the Dow Corning sales specifications in effect at the time of shipment.

Your exclusive remedy for breach of such warranty is limited to refund of purchase price or replacement of any product shown to be other than as warranted.

DOW CORNING SPECIFICALLY DISCLAIMS ANY OTHER EXPRESS OR IMPLIED WARRANTY OF FITNESS FOR A PARTICULAR PURPOSE OR MERCHANTABILITY.

DOW CORNING DISCLAIMS LIABILITY FOR ANY INCIDENTAL OR CONSEQUENTIAL DAMAGES.

Molykote is a registered trademark of Dow Corning Corporation.

Dow Corning is a registered trademark of Dow Corning Corporation.

Freon is a registered trademark of DuPont.

© 2006 Dow Corning Corporation. All rights reserved.

Form No: 80-3305-01

DOW CORNING

*We help you
invent the future.™*

www.dowcorning.com



MOLYKOTE®

FROM DOW CORNING

Molykote® Perfect Lubrication for Textile Machinery



Pasteler Gresler Sıvı Yağlar

Project Sales Corporation, 28 Founta Plaza, Suryabagh, Visakhapatnam 530020, India
www.ProjectSalesCorp.com

Introduction

MOLYKOTE® is a wide range of lubricants used for diverse applications in various types of Textiles machinery. These lubricants are used at OEM level and also in day-to-day machinery operations.

MOLYKOTE® Lubricants & Dow Corning Silicone Sealants are available in various forms and pack sizes.

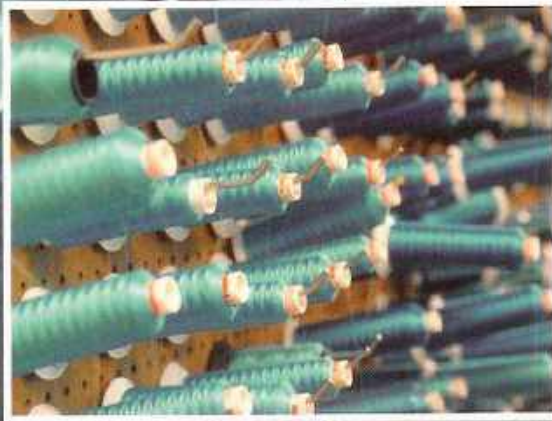

Product range includes :

- Greases, Grease-pastes & Anti-friction coatings
- Industrial Oils - Mineral & Synthetic
- Aerosol spray cans
- Dry lubricants and Anti-corrosion coatings
- Lubricants withstanding extremes of temperatures, speeds, loads & harsh environments
- Silicone Sealants

Services include :

- Lubrication & Reliability training
- Global product quality coupled with local application expertise
- Local inventory & Services provided by Dow Corning Channel-partners
- Plant Training for Optimized Lubrication costs
- Services are provided at reasonable costs

We support you with our expertise in products and services, based on the needs of your application.



Dow Corning has manufacturing plants across the world. In Asia, plants are located at Japan, China and India. Application Engineering Technical Service (AETS) experts are based in all these plants, taking care of your specific needs.

Besides supplying standard range of products, Dow Corning also supports you with product trials and specific product development to fulfil your requirements.

MOLYKOTE® High Performance lubricants from Dow Corning for Textile Industry

Machinery	Components	Key Requirements	Molykote
Blow Room	Chains Open Gears Grease Points	Low friction & Less fluff deposition Low friction, Cleanliness Re-lubrication interval	D-321R / Polygliss N Spray D-321R Spray Multilub Grease
Carding	Flat Driver Gear Box & Coiler Change Gear Box (KH/KHC), Gear Motors	Wear protection	Longterm 00 Fluid Grease (Recommended by M/s Trumac)
	Open Gears	Low friction, Cleanliness	D-321R Spray
	Flats Flexible Bend	Low friction & Less fluff deposition	D-321R Spray (Recommended by M/s Trutzschler)
Sliver lap / Ribbon lap / Comber	Chains Head Stock Gear Box Top Roller End Bushes Other greasing points	Low friction & Less fluff deposits Low friction moderate loads Longer re-lubrication interval Longer re-lubrication interval	D-321R / Polygliss N Spray L-2115 Synthetic Gear Oils G 0100 / G 0102 Grease Multilub Grease
Draw Frame	Chains	Low friction & Less fluff deposition	D-321R / Polygliss N Spray
	Open Gears	Low friction, Cleanliness	D-321R Spray
	Top Roller End Bushes & bottom roller bearing	Speed, Friction & Moderate loads	Multilub Grease - for slow speeds G 2001 / LT W2 Grease - for high speeds
	Other greasing points	Longer re-lubrication interval	Multilub Grease
Speed Frame	Chains	Low friction & Less fluff deposits	D-321R / Polygliss N Spray
	Open Gears	Low friction, Cleanliness	D-321R Spray
	Long Collar Spindle Top & Bottom Rollers	Good penetration Low friction & Long life	Supergliss Oil G4500 / LT W2 / G-0102 Grease
	Spring loaded top arms Worm Gear of overhead traveling cleaner	Cleanliness, Smooth operation Wear protection, avoid oil leakage	DC 557 Silicone Dry Film Spray Longterm 00 Fluid Grease
Ring Frame	Chains	Low friction & Less fluff deposits	D-321R / Polygliss N Spray
	Pocker Rod Top Rollers	Dry lubricant Low friction & re-lubrication interval	DC 557 Silicone Dry Film Spray G 0100 / G-0102 / G 2001 / G 4500 Grease
	Bottom Rollers	Low friction & re-lubrication interval	G 0102 / Multilub Grease
	Jockey Pulley Worm Gear of overhead traveling cleaner	Longer rel-ubrication interval Wear protection, Avoid oil leakage	Multilub Grease Longterm 00 Fluid Grease
Auto Coner	Splicer, Knotter & Cutter for Savio, Murata & Schlafhorst	Cleanliness & Low fluff accumulation	S-0400 AC Spray
	Cams & Followers	Low friction, Moderate loads	A Spray (for 138 / 238 model)
	Cassette type joint gears & Driving part inside winding unit	Low friction, Moderate loads	G Rapid Spray (Recommended by M/s Murata)
	Cams Traverse Motions	Low friction, Moderate loads	DX Paste (Recommended by M/s Savio)
	Package Cradle Adopter	Damping fluid	DC 200 Silicone Fluid
	Cone holder Bearings	Low friction	LT-W2 / G 2001 Grease
OE Machines	Rotor Bearings	High speed	G 2001 / BG555 Grease
	Opening Roller Bearings	High speed	G 2001 Grease



Machinery	Components	Key Requirements	Molykote
OE Machines	Traverse Motion Shaft Spherical bearing, lower distribution pin, table	Cleanliness & Low fluff accumulation Low Friction	S-0400 AC Spray Longterm W2 Grease (Recommended by M/s Schlafhorst for BD 330 model)
	Twin Disc Bearings Twin Disc Oil Gear box Bearings	High speed Low friction Low friction Low friction	G 2001 Grease L-0168 Oil L-0115, L-0122, L-0132 Gear Oil BR 2+ Grease (Recommended by M/s Schlafhorst for Auto Coro model)
	Cam Packages	Low friction	G-n Plus Paste (Recommended by M/s Schlafhorst for Auto Coro model)
Two-for-One Twister	Pot Bearing Gear Box Oil	High speed Load, Low friction	G 2001 / BG 555 Grease Synthetic Gear Oil
Warping	Beam Bearing High Speed Miniature Bearings Rack Lubrication	Moderate load & Moisture Low friction Dry Lubrication	G 0102 G 2001 Grease D-321R Spray
	Drying Cylinder Bearings	High temperature	G4500 / FB 180 Grease
Sizing	Drying Cylinder Bearings (oil lubricated)	High temperature Oil	CO-220 Oil
	Gear Box Telescopic Bearings	Low friction Moderate load	L-0115 / L-0122 Gear Oil G 0102 Grease
Yarn Conditioning Plant	Grease for Lid Seals	Rubber compatibility	111 / 5032 Silicone Grease
Humidification plant	Fan Motor Bearing	Low Friction, Long life	BR 2+ / G 0100 Grease
Circular / Flat Knitting Loom	Needle Lubricants	Low friction, No carbon formation, No staining	L-0622 Oil
	Greasing Point	Low friction	LT-W2 / Multilub Grease
Automatic Looms	Central Lubrication / Geared Motors	Fluid Grease, Low friction, Long life	Longterm 00 Fluid Grease
	Housing Gear	Long servicing life	L-2110 Synthetic Gear Oil
	Dobby Gear	Long servicing life	L-0568 Oil
	Takeup Motion Gear Box	Long servicing life	L-2168 Synthetic Gear Oil
	Let off Motion Gear box	Long servicing life	L-0146 Gear Oil (M55 plus gear oil additive recommended by M/s Piccanol)
	Tappet Cam Gear	Long servicing life	L-0115 Gear Oil
	Leno Selvedge	Long servicing life	L-0132 Gear Oil
	Greasing Points	Low friction and long life	Multilub Grease
	Gliding agent	Low Friction	DC 557 Spray (Recommended by M/s Dornier)
	Selvedge device	Low Friction	PG 75 Grease (Recommended by M/s Piccanol)

Machinery	Components	Key Requirements	Molykote
Automatic looms	Plastic Gears of Leno Device	Low Friction, compatibility	PTFE-N-UV Spray (Recommended by M/s Piccanol)
	Steel wire & Jacquard needle	Low fluff deposition	Pene-lube Spray
Stenter Machine	Fan Bearings Width adjusting screws	High temperature Dry lubricant	FB 180 / G-0100 Grease D-321R Spray
	Stenter chain	High temperature, No carbon deposition, Good wear protection	L-4922 SC Chain Oil / L 1428 Oil
	Stenter chain grease	High temperature, Long life	HP 500 Grease
General Maintenance	Anti friction Bearings (Electric motors, Fans, Pedestal block, etc)	Chemical resistant, Moderate to High loads Water resistant / Multipurpose High temperature	HP 870 / G 6000 Grease G 4700 / LT 2 Plus Grease G 0102 Grease G 0100 / FB 180 Grease
	Threaded connection Turbo charger bolts	Anti-sieze (exposed to high temp.) High temperature anti-sieze	1000 / P 1600 Paste P 37 Paste
	Assembly lubricant 'O' Rings / Gasket / Seals	Anti-sieze for assembly & running-in Compatible to rubber	Gn Plus 111 Silicone Grease
	Electrical Contact Cleaner	Fast evaporation, no residue cleaner	S 1002 Spray
	Rust-loosener	Good penetration, corrosion-inhibitor	Supergliss / Multigliss Spray
RTV Silicone Sealants	Gear boxes, Machines, Engines	Gasketing, Sealing, Insulating High temperature sealing	732 RTV Sealant 736 RTV Heat Resistant Sealant





Limited warranty information - Please read carefully

The information contained herein is offered in good faith and is believed to be accurate. However, because conditions and methods of use of our products are beyond our control, this information should not be used in substitution for customer's tests to ensure that Dow Corning's products are safe, effective, and fully satisfactory for the intended use. Suggestions of use shall not be taken as inducements to infringe any particular patent.

Dow Corning's sole warranty is that the product will meet the Dow Corning sales specifications in effect at the time of shipment. Your exclusive remedy for breach of such warranty is limited to refund of purchase price or replacement of any product shown to be other than as warranted.

DOW CORNING SPECIFICALLY DISCLAIMS ANY OTHER EXPRESS OR IMPLIED WARRANTY OF FITNESS FOR A PARTICULAR PURPOSE OR MERCHANTABILITY.

DOW CORNING DISCLAIMS LIABILITY FOR ANY INCIDENTAL OR CONSEQUENTIAL DAMAGES.

DOW CORNING and MOLYKOTE are registered trademarks of Dow Corning Corporation.

© 2006 Dow Corning Corporation. All rights reserved.

Project Sales Corporation
28 Founta Plaza
Suryabagh, Visakhapatnam 530020
Phone +91-891-2564393 ; 6666482

Your Global Connections

Corporate Headquarters

United States Tel +1 989 496 6000 / 4000

Europe & Asia

China Tel +86 21 2306 5500 • Fax +86 21 6351 2600

Germany Tel +49 611 23 70 / 71 • Fax +49 611 237 620

India Tel +91 22 6694 6868 • Fax +91 22 6694 6848 / 18

Japan Tel +81 3 3287 8300 • Fax +81 3 3287 1088

Spain Tel +34 93 363 6900 • Fax +34 93 363 6901

Turkey Tel +90 216 4643204 • Fax +90 216 4643217

U. K. Tel +44 1676 528 000 • Fax +44 1676 528 001

*We help you
invent the future.™*

www.dowcorning.com

DOW CORNING



MOLYKOTE
FROM DOW CORNING

Smart Lubrication™
www.molykote.com



TM

MOLYKOTE®

FROM DOW CORNING

High Performance Industrial Lubricants for Food and Beverage Processing

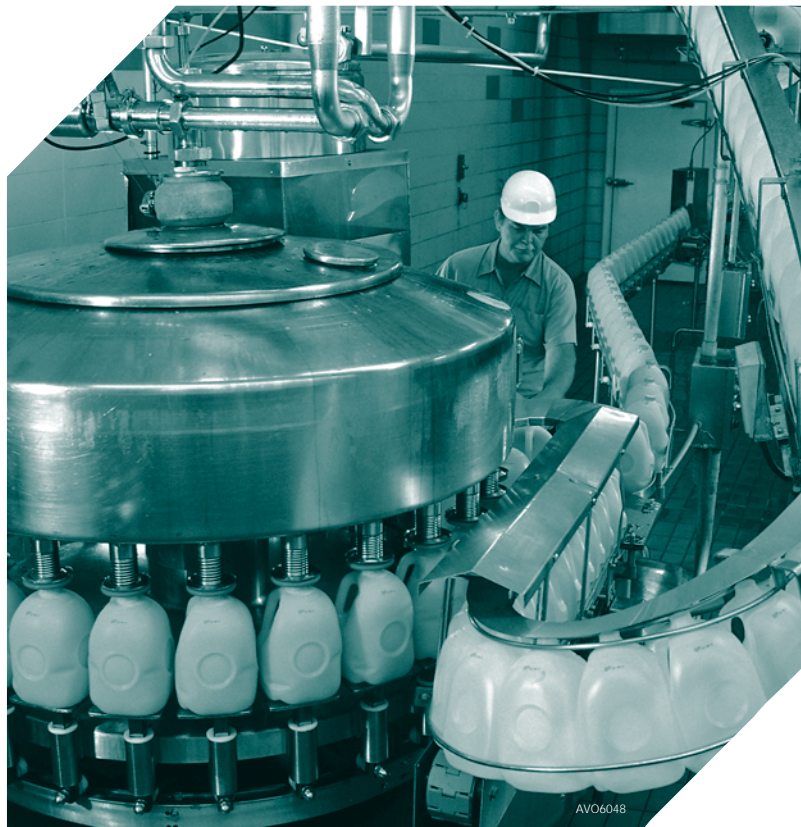

AVO6048

A complete line of industrial lubricants and fluids.



One Trusted Source for All Your Lubricant Needs

For nearly 60 years, OEM designers, maintenance and materials engineers around the world have trusted the Molykote® brand for performance and expertise to solve or prevent virtually any plant lubrication problem. Molykote offers the most complete line of industrial lubricants and fluids available from any single supplier in the world.

Complete Line of Lubrication Products

With Molykote, you get the most complete line of lubrication products available, including mineral oils, synthetic fluids, greases, pastes, anti-friction coatings and dispersions. These products help keep hydraulic systems, air compressors, pumps, gearboxes, chain drives, refrigeration compressors and other plant mechanical systems operating at peak efficiency.

Molykote also offers a complete line of high-performance specialty lubricants that help reduce friction and wear, extend lubrication intervals and reduce maintenance and replacement costs in applications with performance requirements that cannot be met by conventional oils and greases. These products are formulated to withstand heavy loads; dirty, dusty or high moisture content environments; as well as a wide range of temperatures and speeds under extreme conditions.

Excellent Fit For Food and Beverage Processing

Our Molykote High-Performance Industrial Fluids are particularly suited for plant operations in the food and beverage industry. Many Molykote products conform to requirements under NSF regulations, H-1 or H-2 designations of the U.S. Department of Agriculture (USDA), and many are kosher approved and have Ag Canada approvals.

Resists emulsification

Traditional oils can retain dissolved water and emulsify with water, either of which can cause corrosion and lubrication-related breakdowns. But Molykote oils are molecularly engineered for maximum saturation, leaving no nucleation sites to bond with water. Combined with highly responsive additive technology (used at very low levels), Molykote oils inherently resist water throughout their life, making them a smart choice for lubrication in environments needing constant wash downs.

From freezer to oven

In addition, to meet the dramatic temperature variations from freezers to ovens, the product line includes H1 lubricants with operating temperature capabilities from -60°C to 150°C (-76°F to 302°F), and H2 lubricants with temperature capabilities from -60°C to 250°C (-76°F to 482°F). The product line also includes compounds, greases, pastes, anti-friction coatings and dispersions with temperature capabilities from -226°C to 1400°C (-375°F to 2550°F).



Molykote Industrial Lubricants

High Quality, Better Value

Molykote High Performance Industrial Lubricants provide superior performance for nearly every lubrication related requirement in your plant.

Molykote lubricants and fluids meet specifications over a wide temperature range due to the advanced technology of the base stocks. Oil drain intervals typically can be extended because these fluids survive high temperatures and continue to perform as originally specified, which reduces costs associated with oil consumption. In addition, contrary to conventional mineral oils, Molykote products do not contain many of the by-products that cause lubricant degradation. As a result, they help prevent buildup of “varnish” on internal parts, which helps extend equipment life and prevent costly cleaning of fouled components. All these factors add up to more continuous trouble-free operation and lower overall maintenance costs due to superior lubricant performance.

Molykote High Performance Industrial Lubricating Fluids

Molykote synthetic oils are made by combining molecular “building blocks” to meet targeted performance specifications and to minimize impurities. Synthetic oils are formulated with next generation performance-enhancing additives. Molykote mineral oils are produced in a patented hydrocracking process, which ensures that they are nearly free of contaminants. Synthetic blends are composed of synthetic and mineral oil base stocks.

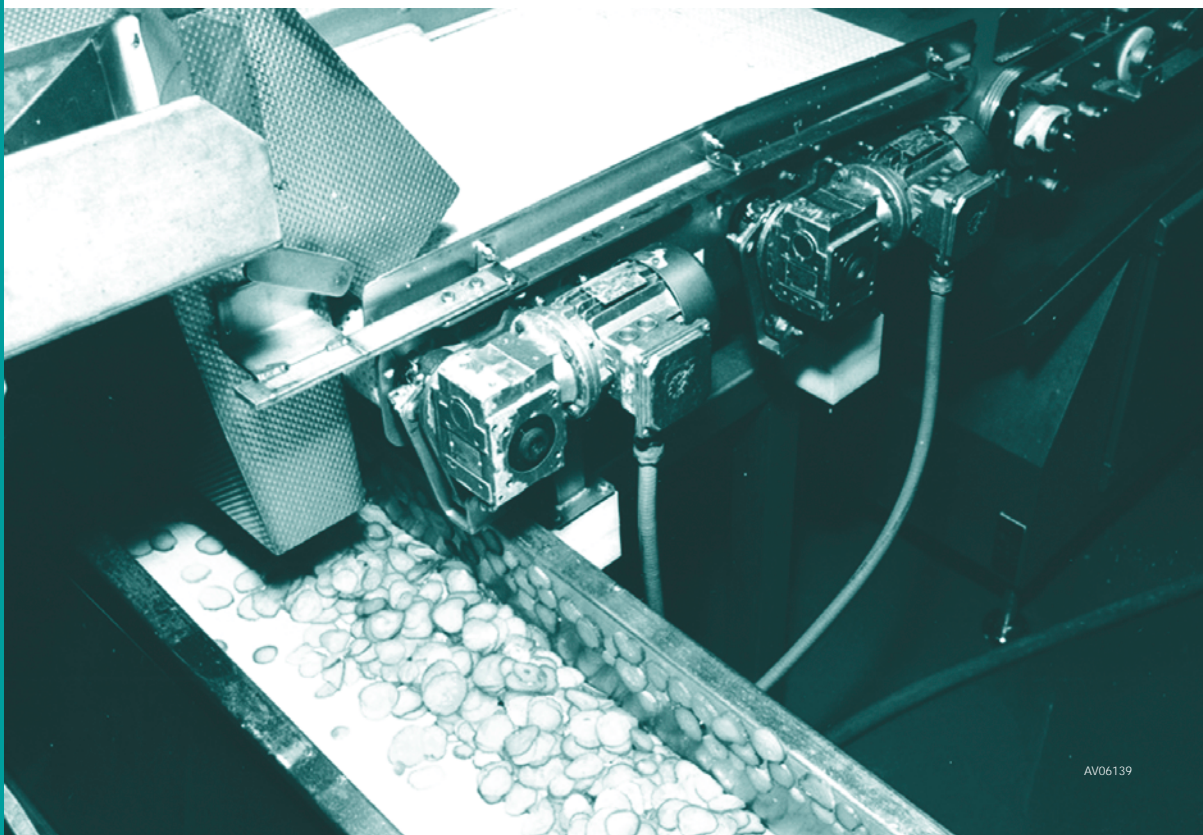

Hydraulic Oils

Molykote hydraulic oils minimize formation of emulsions in contact with water due to the purity of the base fluid. They will generally perform successfully in hydraulic systems far longer than conventional hydraulic oils. Plants can gain significant savings from reduced oil consumption, reduced disposal cost, labor savings and fewer interruptions to production. These non-toxic oils are derived from hydrocracked or synthetic base stocks and can be used in systems designed for low pour point or high flash point mineral oils.

Compressor and Vacuum Pump Oils

Molykote compressor and pump fluids are formulated to meet or exceed the performance of most comparable OEM fill requirements. These compressor and vacuum pump oils are compatible with mineral oils and systems designed for mineral oil lubrication. The Molykote service packages offers oil analysis to ensure that the right food product is used for each application and that product life is maximized.

Gearbox and Chain Oils

Molykote gearbox and chain lubricants help prevent wear and process interruptions in power transmission systems and components. Compared to conventional oils, they also offer greater resistance to oxidation and stable performance at high temperatures and under high loads. Molykote gearbox oils maximize fill intervals and maintain viscosity characteristics at wide temperature ranges.

Multi-Purpose Oils

Molykote multi-purpose oils provide protection and lubrication for a wide range of moving components in industrial systems. Depending on the application, your Molykote representative can help select the right oil from a range of viscosities, additive packages and pour points.

Bearing greases

Molykote high performance greases can be used to lubricate bearings, gears, chains and sliding mechanisms in food and beverage processing application and are suitable for lubrication points with low-to-high loads, moderate-to-high temperatures, and moderate-to-high speed applications.

Molykote High Performance Industrial Lubricants

Benefits to Food & Beverage Processing Plants

- Reduce amount of lubricant suppliers
- Extend interval between lubricant change
- Reduce labor for scheduled and unscheduled maintenance
- Simplify record keeping for Hazard Analysis and Critical Control Point (HACCP)
- Extend lifetime of compressor systems
- Reduce the need for periodic costly internal cleaning of compressors
- Standardize plant use of food-grade fluids and lubricants

Other Molykote Lubricant Types

Types	Lubricating Technology
Greases	MO, PAO, Ester, PIB, Silicone, Fluorosilicones, PFPE
Compounds	Silicone
Pastes	Graphite, MOS ₂ , PTFE, Metallic Oxides
Dry-Film Lubricants	Graphite, MOS ₂ , PTFE, Silicone Wax
Dispersions	Dispersions, MO, PAO, Ester, PIB, PAG

Reference: DE: Diester
MO: Mineral Oil
MOS₂: Molybdenum Disulfide
PAO/MO: Polyalphaolefin/Mineral Oil
PAG: Polyalkylene Glycol Polyolester
PAO: Polyalphaolefins
PFPE: Perfluoropolyether
PIB: Polyisobutene
PTFE: Polytetrafluoroethylene

Molykote Industrial Lubricants

Category/Number		Properties									
	NSF/USDA Category Code	ISO VG	Viscosity, cSt		VI	Pour Point		Flash Point		Density 20°C, g/ml	Base Oil
			40°C	100°C		°F	°C	°F	°C		
Hydraulic Oils											
L-0532FG	H-1	32	31.2	5.3	103	0.0	-18	420	216	0.857	MO
L-0346FG	H-1	46	44.5	6.6	99	-6.0	-21	425	218	0.860	MO
L-0368FG	H-1	68	66.0	8.3	94	5.0	-15	460	238	0.867	MO
L-1346FG	H-1	46	43.1	7.1	110	-6.0	-21	430	221	0.854	PAO/MO
L-1368FG	H-1	68	61.1	9.3	139	-6.0	-21	520	271	0.841	PAO/MO
Chain Oils											
L-0460FG	H-1	68	66.0	8.3	100	10.0	-12	465	240	0.858	MO
L-1468FG	H-1	68	65.8	9.8	131	-65.0	-54	520	271	0.830	PAO
Air Compressor Oils											
L-1232FG	H-1	32	30.2	5.7	138	-76.0	-60	465	241	0.826	PAO
L-1246FG	H-1	46	47.0	7.9	138	-44.0	-42	475	246	0.829	PAO
Ammonia Compressor Oils											
L-0660PS	H-2	68	69.0	9.0	100	-38.0	-39	440	227	0.870	MO
Vacuum Pump Oils											
L-1668FG	H-1	68	63.1	9.0	113	0.0	-18	445	229	0.856	PAO/MO
Special Purpose Fluids											
L-1605FG	H-1	5	5.3	2.0	124	-76.0	-60	335	168	0.800	PAO
Gearbox Oils											
L-0115FG	H-1	150	150.4	15.4	100	-0.4	-18	500	260	0.860	MO/PB
L-0122FG	H-1	220	219.1	20.0	101	-6.0	-21	490	254	0.860	MO/PB
L-0146FG	H-1	460	441.1	33.1	107	0.0	-18	490	254	0.880	MO/PB
L-1115FG	H-1	150	134.7	17.4	122	-38.0	-39	435	224	0.850	PAO/MO
L-1122FG	H-1	220	197.8	24.0	142	-27.0	-33	440	227	0.850	PAO/MO
L-1146FG	H-1	460	380.2	39.2	147	-33.0	-36	545	285	0.852	PAO
Multi-purpose Oils											
L-0510FG	H-1	100	105.1	12.0	103	5.0	-15	495	257	0.866	MO
L-0532FG	H-1	32	31.2	5.3	103	0.0	-18	420	216	0.857	MO
Extreme Pressure Greases											
G-0050	H-1	70 cSt	70 cSt (104F)		0	4-Ball EP weld load, N		Drop Point °F °C		0.890	MO
G-0051	H-1	70 cSt	70 cSt (104F)		1	> 2,940		> 420 > 216		0.890	MO
G-0052	H-1	115 cSt	115 cSt (104F)		2	> 2,940		> 475 > 246		0.890	MO
G-4500	H-1	110 cSt	110 cSt (104F)		2	> 3,100		> 518 > 270		0.840	PAO
G-4501	H-1	110 cSt	110 cSt (104F)		1	> 3,100		> 475 > 246		0.830	PAO
HP 300	H-1	160 cSt	160 cSt (104F)		2	> 3,300		None		2.000	PFPE
Assembly Paste											
P1900	H-1	0.1	Coefficient of Friction*		White Solids	4-Ball EP weld load, N		Temperature Range °F °C		1.110	MO
*Erichsen Screw Test											
Other Spray Oils											
Food Grade Spray	This odorless, tasteless H1 mineral oil spray for food processing equipment is easy to use, offers good penetration, and corrosion protection										
Molykote 316 Silicone Release Spray	Useful in applications where a heat stable, H1 release agent is needed to minimize sticking, or provide lightweight lubrication										



How To Contact Us

For nearly 60 years, OEM designers, maintenance and materials engineers around the world have trusted the Molykote® brand for performance and expertise to solve or prevent lubrication problems. Molykote solutions are available through a distributor network of more than 3,000 channel partners around the globe. To learn more about our extensive product and service offering, visit www.molykote.com or email industrial@dowcorning.com.

LIMITED WARRANTY INFORMATION - PLEASE READ CAREFULLY

The information contained herein is offered in good faith and is believed to be accurate. However, because conditions and methods of use of our products are beyond our control, this information should not be used in substitution for customer's tests to ensure that Dow Corning's products are safe, effective, and fully satisfactory for the intended use. Suggestions of uses should not be taken as inducements to infringe any particular patent.

Dow Corning's sole warranty is that the product will meet the Dow Corning sales specifications in effect at the time of shipment.

Your exclusive remedy for breach of such warranty is limited to refund of purchase price or replacement of any product shown to be other than as warranted.

DOW CORNING SPECIFICALLY DISCLAIMS ANY OTHER EXPRESS OR IMPLIED WARRANTY OF FITNESS FOR A PARTICULAR PURPOSE OR MERCHANTABILITY.

DOW CORNING DISCLAIMS LIABILITY FOR ANY INCIDENTAL OR CONSEQUENTIAL DAMAGES.

Dow Corning and *Molykote* are registered trademarks of Dow Corning Corporation.

© 2004 Dow Corning Corporation. All rights reserved.

Form No: 80-3189-01

DOW CORNING

Speaker seals

Headrest slides

Head up displays

Rollover sensors

Seat belt mechanism

Airbag coating

Anti-squeak and rattle

Leather and textile treatment

LED headlamp controllers

Rear lighting

Door locks

Window lift mechanisms

Linear guides

Sliding guides

Mirror actuators

Sunroof seals

Acoustic barriers

Exterior trim

ABS/ESP controllers

Pedal systems

Hydraulic components

Clutch cables

Hand brake cables

Shock absorber sealing

Steering column

Tire pressure monitoring system

Wheel bolts

Gaskets

Position and knock sensors

Oil gaskets

Intake manifold gaskets

EGR-valve

Piston

Clutch actuation

Automatic gear shifting

CV joints

Electronic fuel injection systems

Fuel cap

Ignition cables

Spark plug boots

Connector seals and grommets

Starter assembly

Alternator assembly

Radiator hoses

Fan clutches

Cooling fan bearing

Electronic heating systems

Flap seals and air ducts

Compressor

Actuators

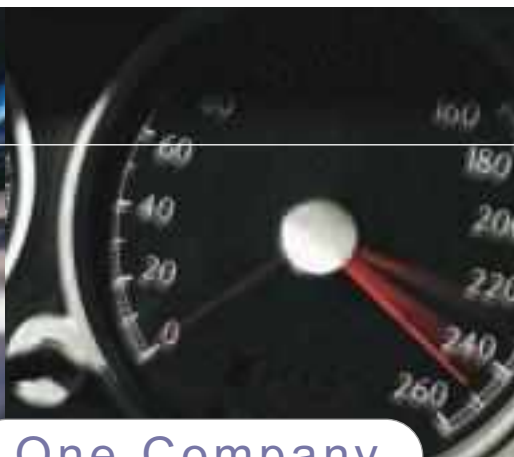

One Company

Many Automotive Solutions



Automotive Solutions



One Company

Many Automotive Solutions

Dow Corning helps lower costs and boost performance of your automotive systems, modules and components.

More than 60 years as a leading automotive supplier gives us a strong foundation of expertise and know-how to meet your unique requirements. We have a long track record of exceeding customer expectations for consistently high quality products and services in just about every aspect of automotive manufacturing. That is the Dow Corning difference.

Around the world, we help companies solve their most demanding business problems. Whether your company is an established leader or a fast-growing start-up, we offer a wide range of products and related services that will keep your business moving forward.

Innovative technology is designed into every one of our products—from our Molykote® brand of automotive lubricants, greases and anti-friction coatings to our Dow Corning® brand of sealants and gaskets. Every product is backed by our commitment to provide design and processing answers when you need them. Our functionality testing, application engineering, and equipment/material integration provide you with a total systems solution.

Learn how we can tailor our products and services for your business.



AV08530



AV08561



AV08527



AV08535

Total Automotive System Solutions

Dow Corning offers exactly what you need: Choice. You will find that our Molykote® and Dow Corning® solutions meet just about every automotive manufacturing requirement. We can provide you with the products and services to enhance the value of your system or components.

Lubrication

Molykote® Lubricants. Dow Corning® Solutions.

Simply put, the right lubricant for a moving part can mean the difference between high performance and failure. When you select Dow Corning as your preferred lubricant supplier, you get access to our extensive offering of Molykote brand lubricants, specialty greases, pastes, anti-friction coatings, oils and dispersions, as well as unmatched application expertise.

Molykote lubricants can be used in situations requiring high pressure or in extreme temperatures, where you have vibration and shock loads, or between sliding surfaces operating under heavy loading. Our anti-friction coatings are designed for many uses, including body and interior applications, which will help you reduce or eliminate problems associated with squeaks and rattles.

Molykote lubricants are designed to perform optimally on a variety of substrates, including metals, elastomers and engineered polymers.

Regardless of the scope and scale of lubrication support you require, we can provide the exact combination of products and/or services that you need to succeed.

Smart Lubrication™ Increases Customer Satisfaction

Molykote® can help you optimize performance and extend the life of component parts and vehicle systems. Combine that with a reduction of squeaks, rattles, noise, vibration and harshness and you get an increase in customer satisfaction.

Following three simple steps can increase customer satisfaction; lead to successful lubrication and long-term component performance.

1. Start Early.

Selecting the right lubricant early in the process can improve product start up and reduce costs by minimizing design changes. Also, proper lubricant selection can prevent component failures and eliminate costly warranty callbacks.

2. Involve Outside Experts to Prevent Problems.

Effective lubricant selection demands support from experts who know the right lubricants to use. This expertise can help prevent problems during the OEM design stage or with long term component and vehicle system failures.

3. Identify a Global Supplier that Delivers Locally.

You can add value by working with Dow Corning. We can provide the same quality from a design concept to the production of parts worldwide. We offer a complete line of automotive lubricants, application expertise and functional testing to assist you.



MOLYKOTE
FROM DOW CORNING

Smart Lubrication™

Sealing Methods

Sealants and Gasketing

Durable Dow Corning silicone-based sealants provide exceptional sealing and gasketing performance in demanding environments, including extreme temperatures.

Typical features of Dow Corning® automotive silicone sealants include:

- Fuel and oil resistance
- Chemical stability in automotive fluids
- UV, ozone and weather resistance
- Superior adhesive strength
- Stability over a wide temperature range
- Excellent dielectric properties

Dow Corning sealants are formulated using a variety of product technologies, each providing strengths and characteristics unique to its chemistry. Dow Corning sealants can be used for many automotive application such as in-place-gasketing for valve covers, transmission covers, and differential covers, as well as adhesive applications such as head lights, mirrors and emblems.

When sealing integrity and component endurance are important, our Dow Corning® Cured-in-Place and Dispensed Foam Gasketing materials can dramatically lower the cost of applying a seal and offer higher value to those providing OEM and/or Tier1 integrators with sealed modular assemblies.

As the leader in silicone technology, Dow Corning has developed the cure technology to meet your application needs that require conventional cure (acetoxo), low odor (oxime), neutral cure (alcoxy), coatings and surface preparation products.

Let us know which product features are most important to your application. We can tailor our products and services according to your specific requirements.



Applications

Body and Interior Components

Body component applications are critical to automotive comfort and reliability. Whether you are a systems integrator, modular component assembler, or individual component manufacturer, Dow Corning has a full range of Molykote® anti-friction coatings and lubricants and Dow Corning® adhesives and sealants to meet your cost and performance requirements.

Dow Corning products are used in a variety of body component applications, including:

- Door and lock systems
- Sun roof
- Mirrors
- Weather seals
- Wiper systems
- Glazing
- Lighting

Interior component applications include:

- Restraint systems
- Multimedia systems
- Seating systems
- Instrument panel systems
- Interior trim
- Accessories (mirror mounts, sun visor, lighting)



AV08532

Powertrain Components and Systems

Dow Corning is a leader in powertrain sealing and lubrication and is committed to providing you with cutting-edge solutions to meet your every-day needs. We are also dedicated to developing products for the next generation powertrain technologies such as fuel cells.

Our Molykote anti-friction coatings and lubricants reduce friction and help to increase the performance and part life of engine gaskets, pistons, air conditioning components, bearings and gears. Our torque transfer and viscous coupling fluids are known industry-wide for their performance in very demanding applications.

Molykote specialty lubricants even include lubricant assembly aids at the OEM/Tier 1 plant level.

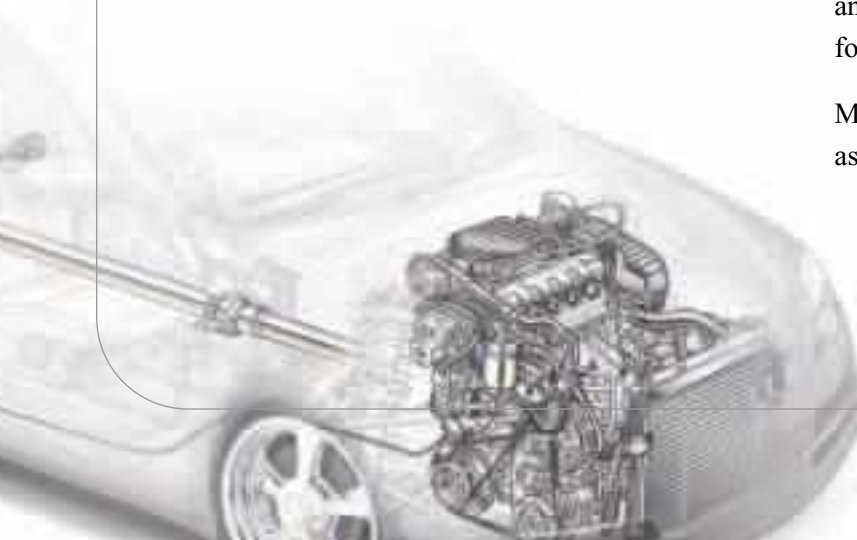

Applications

Chassis and Brake Systems

For decades, Dow Corning products have met stringent safety and performance requirements for applications in chassis and brake systems. We are a global leader in lubrication technology with a network of experts available to solve your application issues.

Our Molykote® materials improve the durability of your chassis and drivetrain systems. You can increase the long-term performance of your brake systems by using Molykote lubricant and friction control additives. For a wide range of brake applications, use Molykote pastes, anti-friction-coatings, low-friction silicone compounds and Dow Corning® automotive sealants.

Electrical Applications

Dow Corning automotive materials extend the performance life of small electrical motors and devices and boost the integrity of other electrical devices throughout the vehicle.

Our Molykote specialty lubricants are designed to meet a wide variety of electrical applications for reliable operation of your automotive switches, bearings and wiring harnesses.

For automotive lighting, our Dow Corning specialty sealants will meet your requirements for high-temperature sealing and non-fogging.

Cooling and Climate Control

Dow Corning materials are used in a wide variety of cooling and climate control applications that include the following:

Engine Cooling

- Radiators
- Water pumps
- Thermostat housing
- Charged air coolers
- Fan clutches
- Hose assemblies
- Cooling fans

Climate Control

- HVAC flapper doors and modules
- Ducts
- Firewall portals and seals
- Cabin filtrations
- AC compressor pistons and clutches
- O-ring assemblies
- Actuators



AV08531



AV08539

Services

Specify and Provide the Best Solution the First Time

Our application engineering provides you a tailored solution. Our process integration assures this is a broad-based solution, not just for a material. Our technical service experts are available to be involved from start-up through production. Leverage these services and our other unique capabilities to gain efficiency improvements. Dow Corning is proud to be your one source supplier by offering:

- One of the most complete line of automotive technologies available from any single supplier (solid, liquid and anti-friction coating lubricants, as well as sealing and gasketing materials)
- Functional testing capabilities, engineering, and prototyping consultations that helps identify problems in the design stage as a means of reducing time to market and engineering design change costs
- Custom prototyping and testing services to help you visualize new product concepts, customize products and services and test them in end-use environments
- One of the most comprehensive ranges of products and services available from a single supplier
- An Equipment Manufacturing Alliance network to provide access to a total system solution from an individual delivery work cell to a completely installed assembly line
- Highly skilled application engineers and technical staff who can relate to car OEMs and Tier I and II suppliers on an engineering basis



AV08325



AV08526

Technical Specifications

As part of Dow Corning's ongoing commitment to the automotive industry, we continuously strive to meet and comply with all relevant technical specifications and quality improvement systems.

We are aligned with the automotive quality system standards by transitioning our existing QS-9000 certifications to the certification of ISO/ TS16949:2002.

We will continue to ensure that our operations remain at the highest level of efficiency and productivity in supplying top quality products and services to our customers.

Dow Corning Automotive: A Total Solutions Offering

Over the past 60 years, Dow Corning has worked to meet and exceed customer needs for consistently high quality products and services for automotive applications. Our capabilities go far beyond lubrication and sealing products and services described in this brochure. The expertise of the various Dow Corning divisions that work for the automotive industry ranges from airbag coatings and electronic insulation materials to ignition wiring and leather coatings.

The illustration below shows you numerous examples of our expertise and gives you an idea of the extensive reach of Dow Corning's offerings for automotive applications.

To learn more about our total solutions approach, visit us at www.dowcorning.com or www.molykote.com.

Cooling and Climate Control

- Radiator hoses
- Fan clutches
- Cooling fan bearing
- Electronic heating systems
- Flap seals and air ducts
- Compressor
- Actuators

Electrical

- Ignition cables
- Spark plug boots
- Connector seals and grommets
- Starter assembly
- Alternator assembly

Powertrain

- Position and knock sensors
- Oil gaskets
- Intake manifold gaskets
- EGR-valve
- Piston
- Clutch actuation
- Automatic gear shifting
- CV joints
- Electronic fuel injection systems
- Fuel cap



Interior

- Speaker seals
- Headrest slides
- Head up displays
- Rollover sensors
- Seat belt mechanism
- Airbag coating
- Anti-squeak and rattle
- Leather and textile treatment

Body

- LED headlamp controllers
- Rear lighting
- Door locks
- Window lift mechanisms
- Linear guides
- Sliding guides
- Mirror actuators
- Sunroof seals
- Acoustic barriers
- Exterior trim

Chassis/Brake

- ABS/ESP controllers
- Pedal systems
- Hydraulic components
- Clutch cables
- Hand brake cables
- Shock absorber sealing
- Steering column
- Tire pressure monitoring system
- Wheel bolts
- Gaskets

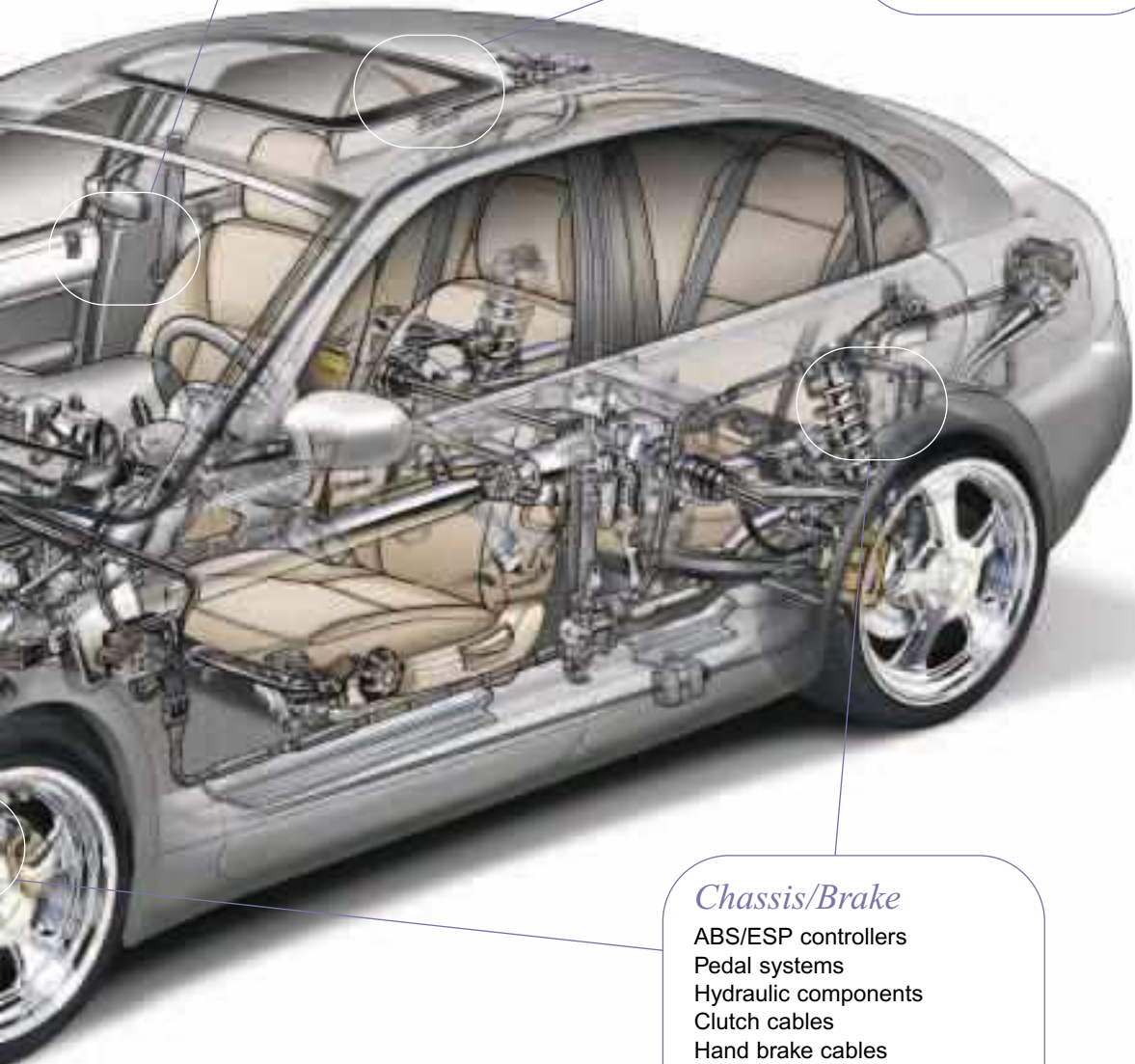

How To Contact Us

Dow Corning has sales offices, manufacturing sites, as well as science and technology laboratories around the globe. For more information, visit www.dowcorning.com or www.molykote.com, or call one of our primary locations listed here.

Your Global Connection

The Americas

World Headquarters (United States)
Telephone: + 1 989 496 6000

Automotive Development Center N. America
Telephone: + 1 734 454 2000

Brazil

Dow Corning do Brasil Ltda.
Telephone: + 55 11 3759 4300

Asia

Asia Headquarters (Japan)
TEL: + 81 3 3287 8300
FAX: + 81 3 3287 1088

China

TEL: + 86 21 6288 2626
FAX: + 86 21 6288 2727

India

TEL: + 91 22 5694 6868
FAX: + 91 22 5694 6848

Korea

TEL: + 82 2 551 7600
FAX: + 82 2 551 6400

Australia & New Zealand

Dow Corning Australia Pty Ltd.
Telephone: + 61 1300 360 732

Europe

European Headquarters (Belgium)
Dow Corning S.A.
Telephone: + 32 64 88 80 00

Germany

Dow Corning GmbH
Automotive Center Europe
Telephone: + 49 611 23 70

France

Dow Corning France S.A.
Sales Office
Telephone: + 33 47 284 1360

Italy

Dow Corning S.p.A.
Sales Office
Telephone: + 39 0298 8321

Spain

Dow Corning Iberica
Sales Office
Telephone: + 34 93 363 6900

United Kingdom

Customer Service Center Northern Europe
Sales Office
Telephone: + 44 1676 528 000

Global Presence. Local Support.

Dow Corning's global presence in the automotive market enables you to develop specifications centrally while providing consistent high-quality products and services locally. Through our global sales, application engineering, product development, and manufacturing and delivery capabilities, our quality is consistent around the globe. This also enables a more effective and efficient product customization process—no matter where you are located!

LIMITED WARRANTY INFORMATION - PLEASE READ CAREFULLY

The information contained herein is offered in good faith and is believed to be accurate. However, because conditions and methods of use of our products are beyond our control, this information should not be used in substitution for customer's tests to ensure that Dow Corning's products are safe, effective, and fully satisfactory for the intended use. Suggestions of uses should not be taken as inducements to infringe any particular patent.

Dow Corning's sole warranty is that the product will meet the Dow Corning sales specifications in effect at the time of shipment.

Your exclusive remedy for breach of such warranty is limited to refund of purchase price or replacement of any product shown to be other than as warranted.

DOW CORNING SPECIFICALLY DISCLAIMS ANY OTHER EXPRESS OR IMPLIED WARRANTY OF FITNESS FOR A PARTICULAR PURPOSE OR MERCHANTABILITY.

DOW CORNING DISCLAIMS LIABILITY FOR ANY INCIDENTAL OR CONSEQUENTIAL DAMAGES.

Dow Corning is a registered trademark of Dow Corning Corporation.

Molykote is a registered trademark of Dow Corning Corporation.

© 2005 Dow Corning Corporation. All rights reserved.

Form No: 80-3267-01

Cover images: AV08537, AV08529, AV08538

*We help you
invent the future.™*

www.dowcorning.com

DOW CORNING



MOLYKOTE

FROM DOW CORNING

ÜSTÜN PERFORMANSLI ENDÜSTRİYEL PASTELER



HSC Plus • G-n Plus • 1000 Paste • P37



ENDÜSTRİ TEKNİK

Kaliteli Çözüm Ortağınız

Molykote® Pasteler, çok yüksek yoğunlukta katı yağlayıcıların ve özel katkıların çok iyi rafine edilmiş mineral kalınlaştırıcıların ileri teknolojik yöntemler ile birleştirilmesinden oluşmaktadır.

1000 Paste

Molykote®1000 katı yağlayıcı paste, aşınmayı azaltmak ve dişli bağlayıcıların ve diğer metaller arası bağlantıların sürtünmesini optimize etmek için kullanılan, kurşun ve nikel içermeyen, yapışmayan ve kalıntı bırakmayan bir pastedir. Uzun süre yüksek ısıya maruz kaldıktan sonra bile problemsiz bir şekilde sökülmeyi sağlar. Yüksek yük altında, geniş bir ısı yelpazesinde çok iyi bir korozyon koruması sunar. Silindir kapak civataları, plastik enjeksiyonlu kalıp makinaları, kimya sanayiinde kullanılan civatalı bağlantılar ve santrifüjlerin gerdirme bileziklerinde başarıyla kullanılmaktadır.

- Geniş bir sıcaklık aralığında kullanılabilir. (-30°C ila +650°C)
- Yüksek yük taşıma kapasitesine sahiptir.
- Yüksek sıcaklıklarda uzun süre kullanımdan sonra bile hasarsız demontaj olanağı sağlar.
- Civataların birkaç kez sıkılıp gevşetilmesinden sonra bile, yağlanmış civataların sürtünme katsayısı değişmez.
- Korozyona karşı mükemmel koruma sağlar.
- Kurşun ve nikel içermez.

HSC Plus Paste

Molykote®HSC Plus katı yağlayıcı paste, yüksek sıcaklıklara maruz kalan metal-metal kombinasyonları ve civatalı bağlantılar için üretilmiş bir montaj-demontaj pastesidir. Düşük hız ve yüksek sıcaklıklara ve korozyona maruz kalan, aynı zamanda düşük ve sabit sürtünme katsayısı gerektiren noktalarda kullanım için uygundur. Üstün elektrik iletkenliği sayesinde kontak yağlayıcı olarak da kullanılabilir. Gaz ve buhar türbinlerinin, dizel motorların turboşarj ekipmanlarının saplama ve civatalarında güvenle kullanılabilir.

- Geniş bir sıcaklık aralığında kullanılabilir. (-30°C ila +1100°C)
- Yüksek yük taşıma kapasitesine sahiptir
- Yüksek sıcaklıklarda uzun süre kullanımdan sonra bile hasarsız demontaj olanağı sağlar
- Sabit sürtünme katsayısı sayesinde öngerilim kuvveti belirlenmiş civatalarda kullanılabilir
- Korozyona karşı mükemmel koruma sağlar
- Kurşun ve nikel içermez
- Çok iyi elektrik iletkenliği sağlar

G-n Plus Paste

Molykote®G-n Plus katı yağlayıcı paste, her türlü makine elemanının sıkı geçme işlemleri ve yeni dişli kutularının alıştırma yağı olarak tasarlanmış yüksek performanslı bir katı yağlayıcı pastedir. İçeriğinde bulunan katkıların ve üstün kalite mineral kalınlaştırıcılar sayesinde uzun ömürlü ve güvenilir bir üründür. Nadiren hareket eden makine elemanlarının kalıcı olarak yağlanması için kullanılabilir. Diş açılmış millerin, dişli çarkların, sonsuz dişli ve transmisyon dişlilerinin, valflerin, pompaların, takım tezgahı klavuzlarının, rondela ve yatakların, flanş ve civataların montajı sırasında güvenle kullanılabilir.

- Montaj ve demontaj işlerinde kolaylık sağlar.
- Yüksek yük taşıma kapasitesine sahiptir.
- Yüksek sıcaklıklarda uzun süre kullanımdan sonra bile hasarsız demontaj olanağı sağlar.
- Sabit ve düşük sürtünme katsayısına sahiptir. ($\mu=0,09$)
- Korozyona karşı mükemmel koruma sağlar.
- Aşınma korozyonu, sürtünme korozyonu ve yenme gibi etkileri minimuma indirir.

Farklı özel uygulamalara yönelik olarak çok geniş bir yelpazede üretilen **Molykote®** Pasteler, aşırı yük, aşırı sıcaklık, aşırı basınç, aşırı hız gibi olağan üstü koşullarda bile üstün performans göstermektedirler. İlk montaj sırasında kullanılabildikleri gibi bakım ve parça değişimleri sırasında da kullanılabilirlerdir.



P-74 Paste

Molykote®P-74 katı yağlayıcı paste, dişli bağlantılar, sürgülü yataklar, doğrusal kaymalı klavuzlar, frezelenmiş miller, sıkı geçme bağlantıları, egzost civataları, buji, vida dişleri, flanşlar, contalar, menteşeler, fren mekanizmaları, balatalar ve tabak yaylarda kullanım için üretilmiş montaj ve demontaj pastesidir. Petrokimya, kimya, kağıt, otomotiv, ağaç ve plastik işleme gibi çok geniş bir yelpazede kullanım alanı bulmaktadır.

- Metal içermez
- Yüksek yük taşıma kapasitesine sahiptir
- Gerilimden kaynaklanabilecek çatlakların ve kırılmanın önüne geçer
- Düşük sürtünme katsayısına sahiptir
- Korozyona karşı mükemmel koruma sağlar
- Geniş çalışma sıcaklık aralığına sahiptir
- Aşınma ve karıncalanmanın önüne geçer

P-37 Paste

Molykote®P-37 katı yağlayıcı paste, çok yüksek sıcaklıklarda çalışmak üzere, katı yağlayıcılar ve özel katkıları ile üretilmiş bir pastedir. 1400°C'ye varan sıcaklıklarda bile üstün performansından hiçbir şey kaybetmez. Gaz türbinleri, fırınlar, buhar türbinleri, enerji üretim tesisleri gibi sıcaklığın son derece yüksek olduğu alanlarda güvenle kullanılabilir. Yüksek saflıkta bileşenlerden oluşan ürün, kurşun, nikelsülfür, klor ve flor içermez.

- Geniş bir sıcaklık aralığında kullanılabilir (-40°C ila +1400°C)
- Yüksek yük taşıma kapasitesine sahiptir
- Gerilimden kaynaklanabilecek çatlakların ve kırılmanın önüne geçer
- Civataların birkaç kez sıkılıp gevşetilmesinden sonra bile, yağlanmış civataların sürtünme katsayısı değişmez.
- Korozyona karşı mükemmel koruma sağlar.
- Kurşun ve nikel içermez.



Cu-7439 Plus Paste

Molykote®Cu-7439 katı yağlayıcı paste, yüksek sıcaklık, yüksek basınç ve korozif çevresel etkilere maruz kalan parçalarda kullanılmak üzere üretilmiş, yüksek performanslı ve bakır içerikli pastedir. Sudan, buhar dan ve korozyona karşı korunması gereken tüm uygulama alanlarında güvenle kullanılabilir. Otomotiv, enerji petrokimya gibi birçok sektörde uygulama alanı bulmaktadır. Egzost civataları, fren mekanizmaları, flanş contaları, buji ve bijonlarda kullanılabilir.

- Yüksek basınç direncine sahiptir
- Çok yapışkandır. Su ile yıkanmaya karşı dirençlidir
- Buharlaştırma oranı çok düşüktür
- Korozyona karşı mükemmel koruma sağlar
- Geniş çalışma sıcaklık aralığına sahiptir
- Damlama noktası yoktur

Ankara Merkez
Arjantin Cd. No:8/2,
06680 G.O.P
Çankaya / ANKARA
Tel : (312) 427 68 08
Faks : (312) 427 68 07

Bursa Büro / Fabrika
HOSAB 1. Cad. NO:21
Karsan Karşısı
Nilüfer / BURSA
Tel : (224) 272 02 43
Faks : (224) 272 00 11

Ankara Depo
1360.sok No: 21
Ağaç İşleri San. Sit.
İvogsan / ANKARA
Tel : (312) 395 27 38
Faks: (312) 395 27 94

İskenderun Büro
Yıldırım Beyazıt Mah. Özkul
Çolak Cad. YSM İşhanı Kat:1 D:2
Payas / İSKENDERUN
Tel : (326) 755 78 60
Faks: (326) 755 78 59

İstanbul Büro
Barbaros Mah.Ihlamur Sk.
My Prestige Kat:14 Da:112
Ataşehir / İSTANBUL
Tel : (216) 410 27 12
Faks : (216) 410 27 16

İzmir Büro
Çiçek Mah. Özgül Armağan Apt.
Çağlayan Sit. D Blok No:76
Bayraklı / İZMİR
Tel : (232) 345 36 33
Faks : (232) 345 23 42



ENDÜSTRİ TEKNİK

Kaliteli Çözüm Ortağınız

Bayiniz





MOLYKOTE®

FROM DOW CORNING

Lubrication Solutions for Threaded Connections



Molykote® Anti-Seize Pastes and
Anti-Friction Coatings from Dow Corning

MOLYKOTE®

LUBRICANTS FROM DOW CORNING

More than 60 years of *trust*,
around the globe.



For over half a century, OEM designers, maintenance and materials engineers around the world have trusted the *Molykote*® brand for performance and expertise to prevent or solve many diverse lubrication problems.

Formulated for extreme loads and environments, *Molykote* lubricants are also ideal for normal service lubrication. They deliver extended benefits as compared to conventional lubricants, such as:

- Long component life
- Extended lubricant durability
- Long maintenance intervals
- Savings of time and money

With technical centers all over the world, our expanded product choices can reach you wherever you are to provide Smart Lubrication™.

Harsh environments, heavy loads and extreme speeds can challenge your productivity. *Molykote*[®] brand Anti-Seize Pastes and Anti-Friction Coatings (AFCs) help keep your equipment and processes moving smoothly.



IMPROVE PERFORMANCE OF THREADED CONNECTIONS

Threaded connections offer several advantages, including, but not limited to, convenient disassembly, repeated use of a fastener and accurate reassembly. However, without proper lubrication, those advantages can be lost, giving rise to significant equipment challenges and reliability concerns.

BY PREVENTING:

- Inconsistent coefficients of friction, resulting in inconsistent bolt tension
- Stick-slip
- Stress corrosion cracking
- Fretting
- Galling
- Seizing

Molykote[®] brand lubricants can help your threaded connections perform well in service, from initial assembly through repeated disassemblies. They are specially formulated to withstand harsh conditions, perform in a wide range of service temperatures and resist the effects of heavy loads, salt-spray or other contaminants.





THE BENEFITS OF PROPER LUBRICATION

Lubricants serve to reduce friction and wear, protect against corrosion and dissipate heat.

The use of carefully selected lubricants can help circumvent some of the common failure mechanisms associated with threaded connections. Some key functions of proper lubrication are:

- Providing a consistent coefficient of friction (μ)
 - On mating surfaces, this enables designers and applicators to minimize the complexity of obtaining proper connector preload forces and torque specifications
 - Limits the effects of temperature and load variations, reducing fatigue failure rates
- Forming barriers between substrates and oxygen gas layer
 - Prevents undesirable scale formation on thread surfaces
- Providing protective layers to mating surfaces
 - Reduces the effects of oxide layer depletion, reducing the occurrence of fretting, galling, seizing and shearing
 - Decreases exposure to corrosive, hydrogen-rich and low-melting metal environments, reducing stress corrosion cracking as well as hydrogen and solder embrittlement

MOLYKOTE® ANTI-SEIZE PASTES PROVIDE CONSISTENT COEFFICIENT OF FRICTION

PRODUCT NAME	μ_t	μ_c	K^*
MOLYKOTE® G-n METAL ASSEMBLY PASTE/SPRAY	0.094	0.087	0.18
MOLYKOTE® G-n PLUS PASTE	0.12	0.06	0.16
MOLYKOTE® G-RAPID PLUS PASTE/SPRAY	0.10	0.06	0.15
MOLYKOTE® 1000 PASTE	0.13	0.08	0.19
MOLYKOTE® M-77 PASTE	0.12	0.12	0.24
MOLYKOTE® P-37 PASTE	0.15	0.09	0.21
MOLYKOTE® P-40 PASTE	0.16	0.08	0.21
MOLYKOTE® P-74 PASTE	0.14	0.08	0.18
MOLYKOTE® P-1900 PASTE	0.10	0.10	0.17
MOLYKOTE® U-n PASTE	0.11	0.11	0.22

*All values in this table were calculated by using the K-Factor formula.

Torque

Proper bolt torque is required to achieve appropriate bolt tension and elongation. Torque must overcome all sources of friction before elongation can occur. Thread and bolt-head friction can be reduced and made consistent by adding a lubricant.

Required torque calculations for proper bolt elongation are made based on threaded fastener geometry and friction of thread and load-bearing surfaces. The friction factor applied to torque calculations is referred to as **K-Factor**. Both thread and bolt-head friction coefficients are used to calculate K-Factor, so it is through lubrication that friction and K-Factor can be controlled to ensure proper bolt tension and elongation are achieved for a derived torque value.

In assembly, the torque energy is first consumed by overcoming friction. The remaining energy is consumed by bolt elongation (which provides the clamping force). Without proper lubrication, too much torque is used to overcome friction, resulting in insufficient bolt elongation.

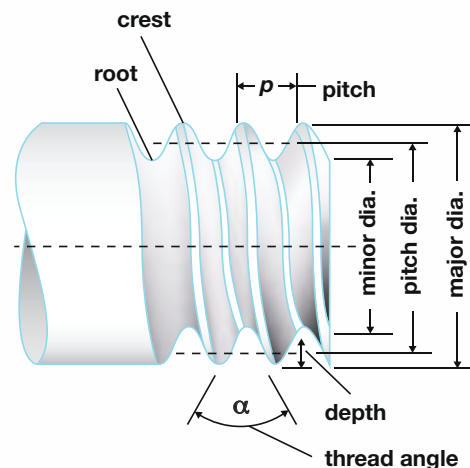

K-FACTOR FORMULA

$$K = \frac{\left\{ \left[\frac{(0.5d_p)(\tan \lambda + \mu_t \sec \beta)}{(1 - \mu_t \tan \lambda \sec \beta)} \right] + [0.625\mu_c] \right\}}{D}$$

Where

D = nominal bolt shank diameter

β = thread half-angle = $60^\circ/2 = 30^\circ$

λ = thread helix angle = $\tan^{-1}(p/\pi d_p)$

d_p = bolt pitch diameter

μ_t = coefficient of thread friction

μ_c = coefficient of collar (head) friction

Failure Mechanisms Defined

Unequal coefficients of friction (μ)

- High μ of mating surfaces (head, nuts, shank and threads) can result in increased twisting of the fastener and reduced clamping force.
- Low μ of mating surfaces can result in excessive bolt elongation.

Stick-slip

The difference between static friction and kinetic friction when two surfaces are in contact.

Stress corrosion cracking

At high temperatures, sulfur diffuses into grain boundaries, producing high stress points. The sulfur then combines with nickel (of alloy steels) to form sulfide crystals. These crystals grow, increasing the stress and creating larger cracks.

Fretting

When vibration induces wear of oxide layers, the oxide particles clog internal clearances, leading to seizure.

Galling

During sliding contact, the oxide layer of threaded materials peels away. Asperities transfer from one part to the other, then break away, destroying the surface and preventing disassembly.

Seizing

Caused by fretting, oxide-free surfaces cold weld under extreme pressure, preventing disassembly.

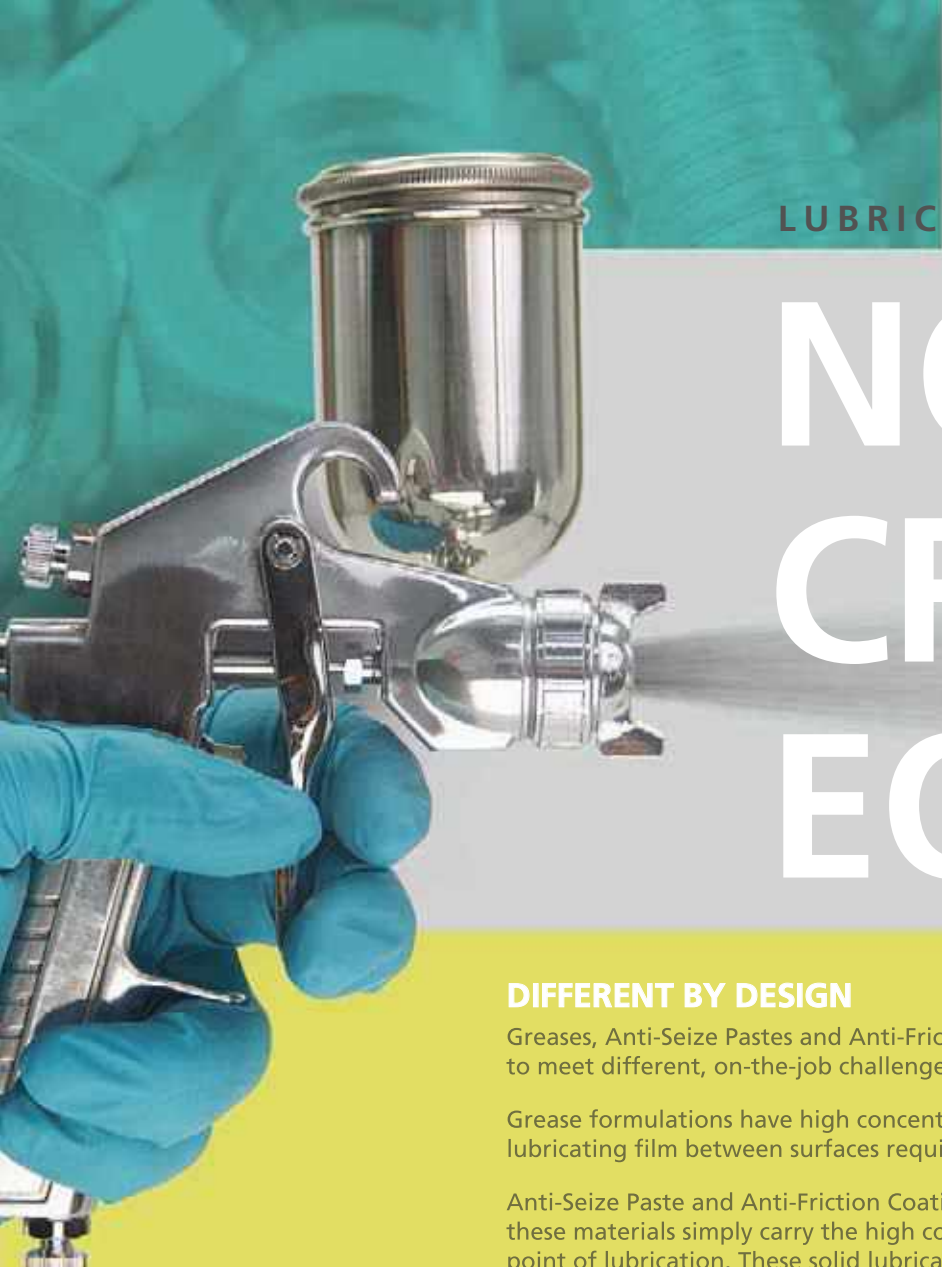

LUBRICANTS ARE

NOT CREATED EQUAL

DIFFERENT BY DESIGN

Greases, Anti-Seize Pastes and Anti-Friction Coatings are each uniquely formulated to meet different, on-the-job challenges and keep equipment running strong.

Grease formulations have high concentrations of base oils, which create the lubricating film between surfaces required to reduce friction and prevent wear.

Anti-Seize Paste and Anti-Friction Coating formulations are different. The base oil in these materials simply carry the high concentration of solid lubricants directly to the point of lubrication. These solid lubricants are not subject to evaporation, and as temperature or pressure increases, the lubricating films maintain their thickness – providing effective, reliable and long-term lubrication of the threaded surface.

To ensure assembly and disassembly of threaded connections over time, the lubricant must stay in place, even under harsh environments. *Molykote*[®] brand Anti-Seize Pastes and Anti-Friction Coatings offer long-term, effective solutions. These lubrication solutions form a protective layer between threaded surfaces, easing assembly and disassembly, while protecting against wear and corrosion that can lead to connection failure.

Greases are designed to bleed base oils, which provide lubrication. But in threaded connections, the lubricant may not carry high load and the base oil will evaporate, reducing grease life.

Anti-Seize Pastes contain a high concentration of solid lubricants for protecting industrial components from galling, fretting corrosion, stick slip, seizure or damage. They provide corrosion

protection, water washout resistance and a consistent coefficient of friction. These solid lubricants remain in place – even at high temperatures and under heavy loads – to help with long-term lubrication. To ensure optimal performance of threaded connections, the appropriate *Molykote* Anti-Seize Paste needs to be selected for the application conditions.

Anti-Friction Coatings are paint-like products that form a slippery film that covers and smoothes surface roughness. This optimizes friction control, even under extreme loads and working conditions. However, the effectiveness and surface life of an AFC is greatly affected by the surface pretreatment of the component, such as degreasing, phosphating, sandblasting and anodizing.

TYPICAL PROPERTIES OF SOLID LUBRICANTS USED IN ANTI-SEIZE PASTE AND ANTI-FRICTION COATING FORMULATIONS

By combining different types of solid lubricants in paste formulations, we get increased protection from fretting corrosion, increased load-carrying and wear prevention.

The sum of what they can do together is superior to what they offer separately.

Anti-Seize Pastes

Molykote[®] brand Anti-Seize Pastes are high-performance products specially formulated for harsh conditions. Unlike conventional greases or compounds, *Molykote* Anti-Seize Pastes create and maintain a lubricating layer, despite extreme loads and temperatures.

Molykote[®] pastes provide:

- Wear protection
- Reliable performance across wide temperature ranges
- Consistent coefficient of friction (μ)
- Water washout resistance
- Corrosion protection
- Immediate lubrication once applied
- Long-term lubrication

Easy, quick and accurate application of Anti-Seize Pastes can be achieved by brushing or dispensed pumping. Some Anti-Seize Pastes are also available in spray form.

Anti-Friction Coatings

Molykote[®] brand Anti-Friction Coatings are very useful for parts exposed to dusty environments or inaccessible areas where long-term lubrication is desired. The parts can be pre-lubricated in a clean environment to reduce handling during field assembly operations.

Molykote[®] brand AFCs are formulated to offer these benefits after curing:

- Dry lubrication
- Coating that is nonflammable

- Film that does not attract dirt and dust
- Additional corrosion protection
- Long-term lubrication without evaporation
- Effective lubrication even after prolonged service life

Application methods include hand or drum spraying, dipping, centrifuging, brushing, roll coating or printing. The best application method is at the discretion of the end user and depends on the geometry of the part being coated.

Graphite

- High temperature stability
- Good lubricant under humidity
- Low coefficient of friction at high loads
- Protects against fretting corrosion

Molybdenum Disulfide (MoS₂)

- High load carrying capacity
- Wide temperature range
- Excellent adhesion
- Protects against fretting corrosion
- Friction decreases with increasing load
- Prevents stick-slip
- Not for use in humid environments

Polytetrafluoroethylene (PTFE)

- Colorless
- Low load carrying capacity
- Low coefficient of friction at low loads
- Good chemical resistance
- Good at reducing sliding friction

Copper

- High load carrying capacity
- High temperature stability
- Should not be used with stainless steel above temperatures of 1000° C (1832° F)
- May promote galvanic corrosion

White Solids

- Protects against fretting corrosion
- Suitable for high temperatures
- Excellent adhesion



Is dry lubrication needed?

YES, my application is exposed to dust, dirt and debris and would benefit from dry lubrication.

Choose *Molykote*® brand Anti-Friction Coatings.

NO:

Choose *Molykote*® brand Anti-Seize Pastes.

Can your part be thoroughly cleaned and dried?

YES:

Choose *Molykote*® Anti-Friction Coatings.

NO:

Consider *Molykote*® Anti-Seize Pastes.

SELECT THE RIGHT LUBRICANT

The *Molykote* Anti-Seize Pastes and *Molykote* Anti-Friction Coatings (AFCs) presented in this brochure are specially formulated for use on threaded connections, helping deliver long-term protection, reliability and productivity.

While *Molykote* Anti-Seize Pastes and *Molykote* AFCs offer many similar benefits, they perform best in specific applications:

- The performance of *Molykote* Anti-Seize Pastes does not require extensive surface preparation, so they are especially useful in the field.
- *Molykote* AFCs must be applied to surfaces that can be thoroughly cleaned and dried, and are often prepared in a clean environment as an engineered solution to help improve maintainability.

When used together, *Molykote*® Anti-Seize Pastes and AFCs can deliver synergistic performance.

You can use the following tables to select the *Molykote* lubricant that best satisfies your needs. For more information and technical specifications or to contact a lubrication expert, visit molykote.com.

Molykote® Brand Anti-Seize Pastes Selection Table

Using Anti-Seize Pastes is one of the best ways to reduce and control friction in threaded connections, ensuring long-term performance and easy disassembly and reassembly. To determine the appropriate Anti-Seize Paste, consider the load, environment, temperature and speed of your application. Below is a general description of Molykote Anti-Seize Pastes that Dow Corning identifies as best suited for threaded connections.

PRODUCT NAME	KEY FEATURES	TEMPERATURE RANGE °C (°F)	SOLID LUBRICANTS							
				Strong Adhesion Capability	Metal-Free Composition	Galling Prevention	Fretting Corrosion Protection	Water Resistance	High Load Carrying Capability	Suitable for Low to Moderate Loads
MOLYKOTE® G-n METAL ASSEMBLY PASTE/SPRAY	• Suitable for general assembly and running-in	-28 to 204 (-18 to 399)	MoS ₂ , white solids	✓			✓		✓	
MOLYKOTE® G-n PLUS PASTE	• Copper-free	Up to 204 (Up to 399)	MoS ₂ , graphite, white solids			✓	✓		✓	
MOLYKOTE® G-RAPID PLUS PASTE/SPRAY	• Provides consistently low coefficient of friction	-37 to 232 (-35 to 450)	MoS ₂ , graphite, white solids				✓		✓	✓
MOLYKOTE® 1000 PASTE	• Good for high load and vibration applications where there is a need to establish consistent torque	-34 to 343 (-30 to 650)	Copper and graphite, white solids	✓			✓		✓	
MOLYKOTE® M-77 PASTE	• Silicone base oil provides higher stability • Stays paste-like at higher temperatures • Compatible with many elastomers and plastics	-43 to 232 (-45 to 450)	MoS ₂					✓	✓	
MOLYKOTE® P-37 PASTE	• High purity • Suitable for stainless, austenite and high nickel chromium steel • Prevents stress corrosion cracking and solder embrittlement	Up to 782 (Up to 1440)	Zirconium dioxide		✓	✓			✓	
MOLYKOTE® P-40 PASTE	• Metal-free • Suitable for water contact	-40 to 649 (-40 to 1200)	White solids and PTFE	✓	✓	✓	✓	✓		✓
MOLYKOTE® P-74 PASTE	• Synthetic base oil carrier • Remains grease-like for longer period of time	-40 to 200 (-40 to 392)	Graphite and white solids			✓		✓		
MOLYKOTE® P-1900 PASTE	• Suitable for food processing machinery • FDA 21 CFR 178.3570 • NSF H1 Classification	-30 to 300 (-22 to 575)	White solids			✓	✓	✓	✓	
MOLYKOTE® U-n PASTE	• Polyalkylene glycol (PAG) base oil • Extremely tacky • Compatible with natural rubber	Up to 188 (Up to 370)	MoS ₂ and white solids	✓					✓	

Molykote® Brand Anti-Friction Coatings (AFCs) Selection Table

Using an AFC is one of the best ways to reduce and control friction in threaded connections, ensure long-term performance, and easy disassembly and reassembly. To determine the appropriate AFC, remember to consider service requirements, the desired coating method and the specific advantages for different applications. Below are general descriptions of Molykote AFCs that Dow Corning identifies as best suited for threaded connections.

PRODUCT NAME	KEY FEATURES	TEMPERATURE RANGE °C (°F)	SOLID LUBRICANT/ BINDER	High Load Carrying	Chemical Resistance	Fuel & Oil Resistance	Fretting Corrosion	Corrosion Resistance
MOLYKOTE® 3402-C LEAD FREE ANTI-FRICTION COATING	<ul style="list-style-type: none"> Room temperature curing High pressure and wear resistance 	-200 to 310 (-328 to 590)	Solids: MoS ₂ Binder: proprietary	✓	✓		✓	✓
MOLYKOTE® D-708 ANTI-FRICTION COATING	<ul style="list-style-type: none"> Heat curing Black glossy finish 	-64 to 240 (-84 to 464)	Solids: PTFE Binder: epoxy		✓			
MOLYKOTE® D-7409 ANTI-FRICTION COATING	<ul style="list-style-type: none"> Heat curing Suitable for high temperatures 	-70 to 300 (-94 to 572)	Solids: MoS ₂ Binder: polyamide-imide	✓	✓	✓	✓	✓
MOLYKOTE® 3400A ANTI-FRICTION COATING LEAD FREE	<ul style="list-style-type: none"> Heat curing Excellent adhesion 	-200 to 260 (-328 to 500)	Solids: MoS ₂ Binder: epoxy	✓	✓		✓	✓
MOLYKOTE® D-321 R ANTI-FRICTION COATING	<ul style="list-style-type: none"> Room temperature curing Available as an aerosol spray 	-180 to 450 (-292 to 842)	Solids: MoS ₂ , graphite Binder: titanate	✓			✓	
MOLYKOTE® 106 ANTI-FRICTION COATING	<ul style="list-style-type: none"> Heat curing Easy to apply 	-240 to 370 (-400 to 698)	Solids: MoS ₂ Binder: epoxy	✓			✓	



Need more information?

Visit molykote.com or contact your Dow Corning Molykote® lubricants distributor to get expert advice.

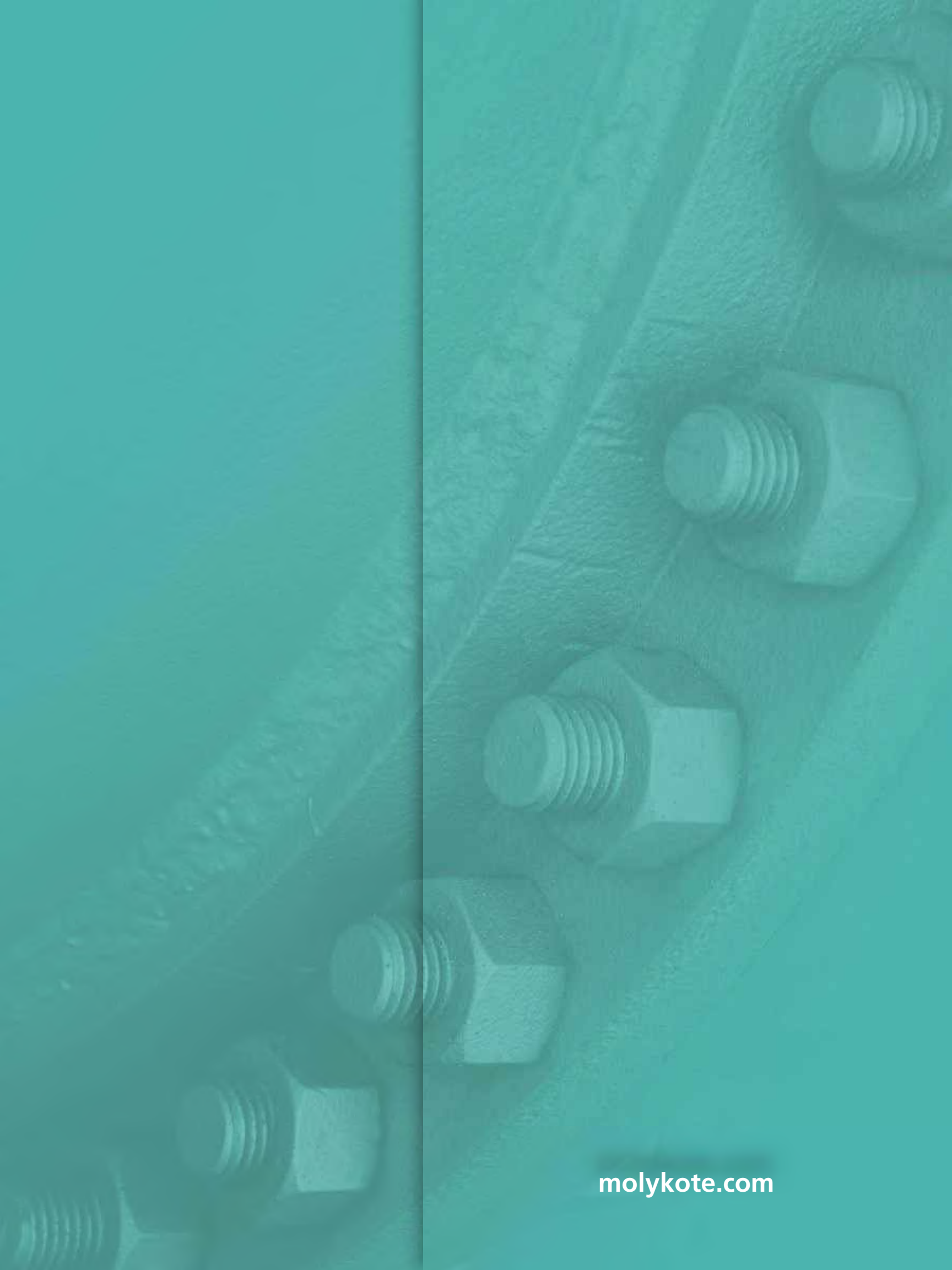

molykote.com

Learn More

Molykote lubricants are available through a distributor network of more than 3,000 distributors worldwide. And, Dow Corning has Lubricant Expertise Centers strategically located globally to provide you with expert technical service and support.

In addition to *Molykote* Anti-Seize Pastes and Anti-Friction Coatings, our other Smart Lubrication™ solutions include multipurpose oils, synthetic and ultra-high-purity mineral oil fluids, specialty compounds, greases and more. Learn more now about our extensive product and service offering by visiting molykote.com or email industrial@dowcorning.com.

Maahantuonti ja myynti Suomessa:

 **YTM-Industrial**
INDUTRADE GROUP

Tiilenlyöjänkuja 9 B, 01720 Vantaa Finland
Tel. +358 29 006 230, fax. +358 10 296 2673
www.ytm.fi, e-mail ytm.info@ytm.fi

Images: Page 1, AV18647; Page 2, AV19522; Page 3, AV19512, AV19520, AV17005; Page 4, AV19519, AV19516; Page 5, AV19513; Page 6, AV19514, AV19524; Page 8, AV19521; Page 10, AV19523; Page 11, AV19515

LIMITED WARRANTY INFORMATION—PLEASE READ CAREFULLY

The information contained herein is offered in good faith and is believed to be accurate. However, because conditions and methods of use of our products are beyond our control, this information should not be used in substitution for customer's tests to ensure that our products are safe, effective and fully satisfactory for the intended end use. Suggestions of use shall not be taken as inducements to infringe any patent.

Dow Corning's sole warranty is that our products will meet the sales specifications in effect at the time of shipment. Your exclusive remedy for breach of such warranty is limited to refund of purchase price or replacement of any product shown to be other than as warranted.

DOW CORNING SPECIFICALLY DISCLAIMS ANY OTHER EXPRESS OR IMPLIED WARRANTY OF FITNESS FOR A PARTICULAR PURPOSE OR MERCHANTABILITY.

DOW CORNING DISCLAIMS LIABILITY FOR ANY INCIDENTAL OR CONSEQUENTIAL DAMAGES.

Dow Corning is a registered trademark of Dow Corning Corporation.

We help you invent the future. is a trademark of Dow Corning Corporation.

Molykote is a registered trademark of Dow Corning Corporation.

Smart Lubrication is a trademark of Dow Corning Corporation.

©2012 Dow Corning Corporation. All rights reserved.

AMP544-11

Form No. 80-3689-01

DOW CORNING

We help you invent the future.™



Molykote® Toolbox Aerosol Range

AEROSOL SOLUTIONS FOR
MAINTENANCE NEEDS

To obtain maximum service life of chain and gear drives and other load bearing components, correct and proper lubrication delivered to load contact areas is essential.

Whether in assembly, maintenance, production or storage, the comprehensive range of Molykote® Smart Lubrication™ aerosol solutions are designed to meet this challenge.

Adding the Molykote™“Toolbox” range to your maintenance kit, not only provides ease of application but will help control friction and wear, reduce fretting corrosion, galling, extend lubrication intervals and improve reliability for tool and component life.

This is but a small selection of the total Molykote lubrication range, for a complete and comprehensive Molykote Specialty Lubricants catalogue please refer to your local BSC contact.



Bearing, Chain & Gear



Molykote® MKLN High Performance Chain Grease (400ml)

Features & Benefits

Molykote® MKLN Chain Grease penetrates, protects & lubricates. Delivers excellent internal lubrication, good adhesion, and wash-out resistance. Temp. -25 to +160°C.

Application Solutions

- High speed high load chain drives.
- Excellent adhesion penetrates with low viscosity carrier delivering adhesive grease and lubricating solids.
- Reduces wear and corrosion.
- Extends chain life.
- Provides top grade chain lubrication in a can.



Molykote® 1122 Chain Open Gear & Bearing Grease NSF H2 Food Grade (312gm)

Features & Benefits

Molykote® 1122 is an extremely adhesive tacky synthetic grease. Superior performance through special adhesion and solid lubricant additives. Provides excellent load carrying capability. Temp. 10 to +160°C.

Application Solutions

- Open gears and chain drives.
- Sliding bearing for slow speeds high loads.
- Applications include hollow pin, tenter clamp, conveyor chains, drying systems and sterilizers.



Molykote® G4500 High Performance Synthetic Grease Spray NSF H1 Food Grade (298gm)

Features & Benefits

Molykote® G4500 is a white synthetic aluminium complex grease fortified with PTFE. Provides a high load capability through a wide temperature range. Meets Food Grade 21 CFR 178.3570 H1 classification. Temp. -40 to +160°C.

Application Solutions

- All general food grade applications. Bearings, gears, chains, cams, guides and splines.
- Compatible with most substrates including industrial composite plastics and rubbers. Clean versatile maintenance tool.



Molykote® Omnigliss Spray Load Carrying Clean Lubricating Oil Spray (400ml)

Features & Benefits

Molykote® Omnigliss provides good penetration, is water repellent, incorporating corrosion protection and high pressure load carrying additives. Clean Lubricating oil spray. Temp. -30 to +80°C

Application Solutions

- Ideally suited to lubricate joints, levers, chains, conveyors, textile, packaging, machinery, filling and packaging equipment.



Assembly, Protection, Prelubrication



Molykote® 1000 Anti Seize Paste Spray High Grade Multi Purpose Assembly Tool (400ml)

Features & Benefits

Molykote® 1000 contains no nickel or lead. Is solid lubricant fortified. Delivers high load capacity coupled with excellent corrosion resistance and a wide service temperature range. Temp. -18 to +1093°C.

Application Solutions

- Suitable for bolted and threaded connections throughout all industrial sectors. Construction, mining, agricultural, chemical processing equipment.
- Proven performance in extremes of temperature, high load or corrosive environments. Provides correct and consistent torque - tension relationship in threaded fasteners.
- Enables non destructive dismantling and reassembly.



Molykote® CU 7439 Plus Anti Seize Paste Spray (400ml)

Features & Benefits

Molykote® CU 7439 is a copper based semi synthetic anti seize paste with superior corrosion inhibitors. Performs well in the lubrication of fastener components & linkages subjected to high temperatures, high pressure water, steam, excessive load, and corrosive influences. Temp. -30 to +650°C.

Application Solutions

- Multiple components requiring protection from water and steam wash out.
- Excellent high temperature capability (no drop point), corrosion resistant. Applications include exhaust bolts, flange seals, studs, brake mechanisms.



Molykote® G Rapid Plus Assembly Paste (400ml)

Features & Benefits

Molykote® G Rapid Plus is a quick and easy to use assembly tool. Well performed as an anti scuffing, running-in, and surface treatment lubricant. Extremely low coefficient of friction combined with high load capacity. Has excellent alloy and metal substrate compatibility. Temp. -35 to +450°C.

Application Solutions

- Handy press fit tool for bearings, pulleys, wheel flanges.
- Ideally suited in lubrication and running in of gears, spindles, threads and guides.
- Reduces seizure scoring and fretting corrosion.
- Also suited to the lubrication of bearings, sliding surfaces in high load slow intermittent or oscillating applications.



Molykote® D321R Dry Bonded Lubricant (400ml)

Features & Benefits

Molykote D321R is a paint like fast air drying anti friction coating (AFC) with a wide operating temperature range. Adheres tenaciously to clean substrates. Quick drying delivering long term lubrication in high load and difficult dusty dirty operating conditions. Ideal selection for areas where it is difficult to maintain lubrication film. Temp. -180 to +450°C.

Application Solutions

- Suitable for dry lubrication of bearing surfaces chains and gears in dusty dirty operational conditions.
- Pre lubrication coating for running in of gears limiting initial start up wear.
- Aids cold extrusion.
- Provides lubrication under high vacuum and extreme temperatures.
- Suited for longterm lubrication external or internal oscillating, pivoting movements or mechanisms.
- Applications include switches, locks, hinges as well as components in rotor head of wind energy installations.

Clean Lube, Non-staining, Tool Room



Molykote® 316 Silicone Release Spray NSF H1 FG (283gm)

Features & Benefits

Molykote® 316 is a high quality Industrial & food grade release spray with a pure silicone formulation from Dow Corning®. It is stable in performance, through a wide temperature range, transparent, non staining or contaminating. Displays excellent compatibility with metal plastic rubber surfaces. Food grade meets 21 CFR 178.3570 H1 classification. Temp. -40 to +200°C.

Application Solutions

- Prevents build up, sticking in extrusion and packaging equipment.
- Aids release and movement in boning, cutting, sawing tables, benches and cooking equipment.
- Reduces hang up in vending machines and adhesion of produce to glue pots, ovens and burners.
- Improves movement in the processing and packaging of frozen and dry foods, magazines, bundled paper and cardboard.



Molykote® S-1011 Non Silicone Release Spray (400ml)

Features & Benefits

Molykote® S-1011 is silicone free mould release spray. Contains non silicone release oil. Temp.-55 to +220°C.

Application Solutions

- Treatment of moulds for excellent release of plastic parts where a silicone free coating required.
- Aids post production treatment of surfaces i.e. painting etc.



Molykote® PTFE-N Spray (400ml)

Features & Benefits

Molykote® PTFE-N spray is a translucent dry film anti friction coating (AFC), with extremely low coefficient of friction. Air drying lubricant, non staining, providing excellent adhesion, long term lubrication and reduced friction and wear. Temp. -180 to +240°C.

Application Solutions

- Suitable for rubber guides, sliding doors, sunroofs, hinges, windows, small mechanisms in office equipment, electrical and home appliance industries.



Molykote® 557 Silicone Clean Dry Film Lubricant NSF H2 Food Grade (312gm)

Features & Benefits

Molykote®557 is an extreme pressure dry film lubricant. Wax like film provides exceptional lubricating and release properties. Colourless and non staining. When applied provides a thin film long-lasting EP lubrication extending tool and blade life. Temp. -40 to +55°C.

Application Solutions

- Extends operating life of forming tools, punches, taps dies, drills, knives, scissors, and slitters.
- Reduces wear, stick slip and pick up.
- Clean lube on slides cams and guide ways.
- Provides improved tool performance and profile surface finish in aluminium and other metal industry production processes.
- Ideal inclusion in every tool room maintenance kit.



Molykote® Food Grade Oil Spray NSF H1 FG (400ml)

Features & Benefits

Molykote® Food Grade Oil Spray is a versatile mineral oil spray for food processing equipment. Odourless and tasteless. Meets 21 CFR 178.3570 HI classification. Temp. -10 to +120°C.

Application Solutions

- Easy to use, good penetration, high corrosion protection, high load capability.
- General lubrication of mechanical components in food & beverage processing equipment.



Molykote® Metal Protector Plus (400ml)

Features & Benefits

Molykote® Metal Protector Plus is a transparent, non greasy, wax like corrosion protection film in a non toxic solvent. Components treated when dry can be handled transported or stored with corrosion protection. Compatible with common lubricants so usually no need to remove prior to equipment re use.

Application Solutions

- Protects costly machine tools, dies, moulds, and precision steel components during handling, transportation or storage.
- Quick easy application dries room temperature 90 Mins.



Complete product and material safety data sheets available on request, please call our technical support team:

Phone: 02 9822 5806 Fax: 02 9822 5056







MOLYKOTE®
FROM DOW CORNING

Lubrication Solution for Steel & Cement Industries



Extends equipment life & simplifies yours
Pastes • Greases • Compounds • Oils • Dispersions



Molykote® Solutions for Steel and Cement Plant from Dow Corning

In demanding industries such as steel and cement where your goal is to reduce operating costs per ton while producing quality product in elevated temperatures, heavily loaded conditions, and harsh chemical environments, you need a lubricant you can count on.

Dow Corning knows what it takes to keep your operation running smoothly. Whether it's quarrying and extraction operations, storing, milling and firing in the cement industry or the coke plants, blast furnaces, melt shops, casters and rolling mills in the steel industry, we have the experience and expertise to keep your operation running smoothly.

Our comprehensive line of Molykote® brand lubricants are engineered to meet or exceed OEM performance specifications to help you maintain equipment availability and extend service life for all your critical components, including:

- Bearings
- Chain Drives
- Compressors
- Open gear Drives
- Enclosed Gearboxes
- Electric motor bearings
- Slip Seal Liners in Kilns

Complete Line of Lubricants

Molykote® offers one of the most complete lines of industrial available, from greases and pastes to mineral and synthetic oils to protect your equipment.

Molykote® lubricants are formulated to handle the high temperatures and pressure, water contamination and harsh abrasives of steel mills and cement plants. They resist washout and retain consistency in extreme environments to help keep equipment running longer.



Molykote® application Chart in Steel Plants

Raw Material Plants

Coke Oven	ESP Insulator High Temperature Area Chemical Attack Area Valve Lubrication	Dow Corning DC-5 Compound Molykote® G-0106, G-6000, P-40 Molykote® FS-3452 or HP-870 Dow Corning 111 Compound
Lime and Dolomite Plant	Open Gear Lubrication Spray / Sump Enclosed gear Box Bearings	Molykote® KGP-2P / LT-00 Molykote® Gear oils - synthetics Molykote® Longterm- 2 plus
Sinter Plants	Crushers Bearings Screen Bearings Sliding Track Lubrication Sinter Pallet Wheel Bearing Open Gear Lubrication Gear Boxes	Molykote® Longterm- 2 Plus Molykote® Longterm- 2 Plus Molykote® G-0103 Molykote® G-0103 Molykote® KGP-2P Molykote® Gear oils

Iron Making

Blast Furnace	Bell less Top Gear Box Bell less top bearing Lube Wire Rope Lubrication in Skip Car Hydraulic Mud Gun Chain - Mudgun Slurry Pump Bearings Torpedo Ladels	Molykote® Gear oils Molykote® G-0106 Molykote® LT-00 / Z Powder Molykote® G-0106 / FB-180 Molykote® M-30 Dispersion Molykote® Longterm- 2 Plus Molykote® Cu- 7439
---------------	--	---

Steel Making

SMS	Gear Boxes Cranes Wire Ropes Trunion Lubrication of Ladle Lancing Pipes Threaded Joints Over head crane wheel Bearing Over Head Crane Leaking Gear Boxes	Molykote® gear oils Molykote® Z Powder / LT-00 Molykote® P-37 Molykote® P-37 Molykote® Longterm - 2 Plus Molykote® Longterm - 00
-----	---	---

Primary Mills

Casters	Turret Open Gear Lubrication Oscillator Bearing Lubrication Slide Gate Mechanism Mould Foot roll	Molykote® 1122 Molykote® P-74 Molykote® P-37 Molykote® P-40
---------	---	--

Mills and Secondary Mills

Slab/ bloom/ billte/ CSP	Caster Bearing Lubrication of Segment and cooling bed	Molykote® G-0102, P-40, G-6000, G-0106
Rolling Mills	Roll Neck Bearing Lubrication Roll neck Journal Lubrication Roll chock Seal Lubrication Window Linear Lubrication Gear Coupling Lubrication Universal Coupling Lubrication Furnace Roll Table Bearings Roll Table conveyor Geared Motor Chain Lubrication	Molykote® G-0102, G-0103 Or G-0105 Molykote® TP-42 Dow Corning 111 Compound Molykote® Cu-7439 Molykote® Longterm 2 Plus/ G-4700 Molykote® G-0103 Molykote® G-0103/ Molykote P-40 Molykote® G-0101 Molykote® M-30 Dispersion

Assembly and Central work Shop

Assembly Application	General Assembly in Work Shop - Press Fits Pneumatic Lines Hydraulic Cylinders Dry Lubricants for Metals Surface Only Corrosion Protection Rust Loosener Gear Box Parting Lines in-place gaskating Pitted Gear Boxes -to arrest Pitting Development Cleaning of Metal Surface	Molykote® GN Plus Molykote® 55 M for O rings Dow Corning 111 Compound Molykote® Z Powder Molykote 321-R Spray Molykote® Metal Protector Plus Molykote® Penelube/ Multigliss Dow Corning 732 RTV/ 733 RTV etc. Molykote® M Gear Gurd OS 2 Metal Cleaner
----------------------	---	--

Electrical Deptt - and Utilities

Electrical Application	Lifting Magnet Potting Application Electrical Motor Bearing Thyristor application- Heat Sink Compound Electrical Contact Cleaner	Sylgard 170 A & B Molykote® G-0100 Dow Corning 340 Heat Sinking Compound Molykote® S-1002
------------------------	---	--

Molykote® Cutting Edge Solution and Service Information

Solutions and Services to Meet Your Needs



As experts in industrial lubrication, Molykote® products from Dow Corning can help you keep your equipment running at peak condition by improving reliability to reduce maintenance and downtime.

Together with our distribution partners, local sales, technical

support and consulting partners, we can provide you with the following solutions and services:

- Engineering and Reliability Studies
- Lubrication Management
- Periodic Equipment Inspection
- High Performance Lubricant Selection
- Lubricant Analysis and Failure Analysis
- Lubricant Handling and Performance Cost Analysis
- Safety and Environmental Audits.

Training and Contract Services for Optimizing Lube Inventory

Molykote® High-Performance Lubricants

Molykote® high-performance lubricants help reduce friction and wear, extend lubrication time and reduce maintenance and replacements costs. Formulated to withstand the rigors of heavy loads, dirty, dusty or chemically harsh environments, temperature and speed extremes, Molykote® are also ideal for normal service lubrication. Each product offers good lubricity, manages friction, extends service temperature range and increases warranty life. In addition, Molykote® lubricants are non-toxic, environmentally friendly, and meet all international regulatory requirements.

Our product range and engineering expertise make us the ideal partner to meet any of your plant lubrication needs.

- Tailored approach – Dow Corning has global capabilities but can tailor a solution that can satisfy local needs.
- Simple and exact – We offer a wide selection of specialty lubricants for all applications to help you make the right choice the first time, which can help you reduce inventory and increase productivity.
- Environmentally friendly – Our lubricants and silicone-based products do not contain heavy metals or unwanted chemicals.
- Total solution – In addition to specialty lubricants, Dow Corning has a full range of silicon-based sealants that offer exceptional performance characteristics and can meet a wide variety of your industrial bonding and sealing needs.

Learn more about Molykote products and services

To select the best lubricant for your application, contact a Molykote representative today.

Some critical Application	Product*	Benefit
Integrated Steel Plant, Sponge Iron Plants & Cement Plant	Molykote® & Dow Corning product	Reduce cost & Reliable operation
Open Gears using Dip & Spray Lubrication	Molykote® KGP 2P series	Reduce cost & Reliable operation
Slip Seal Mechanisms in Kilns	Molykote® G-0103	Reduced cost of operation
Segmented Liner & Fasteners	Molykote® 1000 paste	No seizing
Conveyor head Pulleys	Molykote® Long term 2 Plus	Reduced failures
Support Roller Bearings	Molykote® Long term 2 plus	Reduced Lube consumption
Coal Impactors & Crushers	Molykote® Long term 2 plus	Reduced Labour and bearing failure
Hammer Crushers	Molykote® Long term 2 plus	As above
Motors and Pumps	Molykote® G0100	As above
Vibratory Screens	Molykote® Long term 2 plus	As above
Chains and Hydraulic Cylinders	Chain oils and Dow Corning 111 Compound	Increased component life
Screen Bearings	Molykote® Long term 2 Plus	
Blender Reclaimers	Molykote® Long term 2 plus	Increased bearing life
Continuous Casting Machines Segment Bearings	Molykote® G 0102/0103/0106/P40	Increased bearing life
Conveyor & Table roll Bearings	Molykote® G0102/G0106	Reduced failure
Roll Neck Bearings in Rolling Mills	Molykote® G0102/G0103/G0105	Reduced Lube consumption
Motor & Blower fan	Molykote® G0100	Reduced grease consumption

Molykote Sprayable Lubricants for Open Gear Drives

The Lubrication requirements of Open gears in rotary equipment is very demanding and correct Lubricant selection is critical to maximize the Girth Gear Life.

Key Functions of Sprayable Open Gear Lubricants :

- To reduce friction & control wear between the pinion & gear pressure flanks.
- To cushion shock loads to minimize metal to metal contact at the pressure flanks

Lubricant Selection Criteria are :

- Load
- Temperature
- Economics
- Speed
- Environments
- OEMs

Products and Services Used for trouble free Operation of large Open Gear Drives :

- Priming Paste → Molykote® Q3-4612
- Sprayable Running-in Grease → Molykote® KGP-2/P-E
- Sprayable Service Lubricants → Molykote® KGP-2/P & KGP-2 Plex-1500
- Repairs (special service) → Molykote® services of assisting you in drive alignment and repairs



Molykote® making the difference :

Molykote® Unique "Running in" Process- "No Wear- Plastic Deformation" Technology, protects your Girth gear several times more compared to "Wear Type" Running in process. Our unique technology has been demonstrated in field application giving user a trouble free gear drive for as long as Ten years.

A richly fortified solid Lubricating "Priming Paste"- Q3-4612 with Unique "Running in" sprayable grease KGP 2PE gives your open gear drive, the first "vaccine against pitting".

Our Service lubricants have a base oil viscosities of only, 1000 cSt and 2500 cSt (KGP-2/P & KGP 2-PLEX-1500 respectively), as per latest equipment demand, design (AGMA) and reliability parameter.

Approvals from major OEM's : FLS, Outokumpu, FFE Mineral Systems, BHEL, Tata Growth Shop, Walchandnagar Industries, are some key International and National OEMs to approve our products.

Continuous technical assistance is provided during : Start up, Running-in, operations & repairs.

Ongoing Technical Support :

- Lubrication management planning
 - Equipment evaluations
 - Engineering studies
- Regular equipment inspections
 - Temperature
 - Vibration Monitoring and Trending
- Gear Teeth Condition Photographs
- Performance and cost analysis

Customer Voice : Benefits of using Molykote Products and Services

- Scheduled Downtime is reduced and unscheduled stoppage has been avoided.
- Enhanced production achieved without capacity expansion.
- System Reliability increased; chances of human errors are minimized.
- Lubrication-related failure costs has come down.
- Manpower costs as a percentage of total lubrication costs are controlled.
- Molykote® product & services have a proven track record of Reliable Performance.





Limited warranty information - Please read carefully

The information contained herein is offered in good faith and is believed to be accurate. However, because conditions and methods of use of our products are beyond our control, this information should not be used in substitution for customer's tests to ensure that Dow Corning's products are safe, effective, and fully satisfactory for the intended use. Suggestions of use shall not be taken as inducements to infringe any particular patent.

Dow Corning's sole warranty is that the product will meet the Dow Corning sales specifications in effect at the time of shipment. Your exclusive remedy for breach of such warranty is limited to refund of purchase price or replacement of any product shown to be other than as warranted.

DOW CORNING SPECIFICALLY DISCLAIMS ANY OTHER EXPRESS OR IMPLIED WARRANTY OF FITNESS FOR A PARTICULAR PURPOSE OR MERCHANTABILITY.

DOW CORNING DISCLAIMS LIABILITY FOR ANY INCIDENTAL OR CONSEQUENTIAL DAMAGES.

DOW CORNING and MOLYKOTE are registered trademarks of Dow Corning Corporation.

© 2007 Dow Corning Corporation. All rights reserved.

Ref. No. 80-3341-01

Your Global Connections

Corporate Headquarters

United States Tel +1 989 496 6000 / 4000

South America

Brazil Tel +55 19 3887-9797 • Fax +55 19 3887-9798

México Tel +52 555955-1300 • Fax +52 555955-1327

Europe & Asia

China Tel +86 21 2306 5500 • Fax +86 21 6351 2600

Germany Tel +49 611 23 70 / 71 • Fax +49 611 237 620

India Tel +91 22 6694 6868 • Fax +91 22 6694 6848 / 18

Japan Tel +81 3 3287 8300 • Fax +81 3 3287 1088

Spain Tel +34 93 363 6900 • Fax +34 93 363 6901

Turkey Tel +90 216 4643204 • Fax +90 216 4643217

U. K. Tel +44 1676 528 000 • Fax +44 1676 528 001

*We help you
invent the future.™*

DOW CORNING

www.dowcorning.com



MOLYKOTE®
FROM DOW CORNING

Smart Lubrication™
www.molykote.com



MOLYKOTE[®]
FROM DOW CORNING

Long-life Lubricants for Brake Systems



Driving technology and service for worldwide performance.

Long-life lubricants for demanding brake systems

The right lubricant can mean the difference between whether a moving part performs or fails. That's why it's especially critical to choose the right lubricant for a brake system.

Dow Corning offers a complete line of both general-purpose and specialty lubricants. Many are high-performance lubricants especially designed for automotive brake system applications. They go beyond the capabilities of conventional oils and greases to:

- reduce noise
- achieve long-life lubrication
- reduce fretting wear
- reduce stiction
- withstand extreme conditions
- reduce judder

Our lubricants are designed to keep working under extremes of load, speed, and temperature. They hold up even in the most difficult environments where exposure to water, dust, or corrosive chemicals might attack and degrade ordinary lubricants. They also offer good compatibility with elastomers commonly used in automotive brake systems, such as EPDM and neoprene.

You can expect our lubricants to provide extended lubrication periods and reduced warranty and replacement costs. They can even provide maintenance-free, long-term lubrication in many applications.



AV04641

Products to meet your braking needs

You can select from our extensive line of *Dow Corning*[®], *Molykote*[®], and *Lubolid*[®] brand lubricants—both “wet” (e.g., greases) and “dry” (e.g., anti-friction coatings). They are formulated from a wide range of base oils, including silicone, polyalphaolefin, polyglycol, mineral oil, ester, and perfluoropolyether. In addition, many of our lubricants incorporate solid additive technology.

Our multi-technology products come in five forms:

Greases. High-performance greases are designed for dynamic metal-to-metal, metal-to-rubber, metal-to-plastic and plastic-to-plastic applications.

Most greases are based on synthetic formulations that have excellent resistance to thermal degradation. Many are fortified with solid lubricant additive technology to provide effective lubrication under extreme load conditions.

High-performance fluorinated greases are designed for extended service at higher temperatures and higher loads, and in harsh chemical environments.

Compounds. Silicone compounds are greaselike lubricants that generally contain silicone fluids and inert silica fillers. They are resistant to oxidation while maintaining their properties over a wide temperature range. They're ideal as non-curing sealants or as release agents between metal and elastomeric materials.

Pastes. These lubricants have high concentrations of solid lubricants blended in various bases. They are used where a high concentration of solid lubricant is required, such as initial run-in and areas exposed to high loads.

Anti-Friction Coatings. In simple terms, anti-friction coatings can be thought of as lubricating paints. They typically contain a select blend of solid lubricants and a binder dispersed in a solvent carrier. After curing, the coating forms a dry lubricating film that can help prevent corrosion and is aesthetically pleasing.

Anti-friction coatings are ideal for applications involving dusty environments or for inaccessible areas containing parts that need long-term lubrication.

Lubricating Solids. These lubricants are primarily used as additives for plastics and friction lining formulations to improve wear resistance and control friction.

They offer good thermal stability and are resistant to wear.

Service and support from start to finish

Our global automotive centers feature a wide range of equipment for designing, prototyping, testing, and validating our lubricants and other materials in specific applications. We are able to work with you to evaluate and analyze material options, as well as provide samples or prototypes for validation and preliminary estimate of production usage rates.

You can rely on our people to help you select the right lubricant for your brake system application. But we don't stop there.

We think it's important that the lubrication process properly fits into your manufacturing scheme. To that end, we'll work with you to develop the right delivery system to apply our lubricants to your product. That means we can offer options beyond traditional drums and pails for specialized needs.



AV04645

It also means we can make recommendations for matching our lubricants to the best application equipment. We can even work with you and the equipment supplier(s) to help you put together the right process.

To learn more about how we make sure our products meet both your expectations and ours—as well as how they stack up against the competition—read on.



AV04646



Our regional automotive centers, located in Germany, Japan, Korea, Brazil, and the U.S., have the people and equipment in place to meet your needs. We also have R&D facilities at our corporate headquarters in Midland, Michigan.

We conduct a variety of ASTM, DIN, ISO, and other standard tests at these facilities. The North American facility, for instance, features specialized test equipment such as a high frequency reciprocating tester, which enables us to simulate real-life duty cycles. It also helps us compare how well our lubricants stand up against those from other suppliers.

A comparison of stiction is shown in figure 4. Note the lower value for Molykote G-807 Low Friction Silicone Compound, compared with competitive PAG and conventional silicone products, indicates that the Molykote product will slide more smoothly over rubber, reducing stiction and resulting in longer brake life.

Figure 5 shows the effect of high frequency oscillation under load on lubricant breakdown and failure. Note that Molykote® G-407 Anti-Fretting Grease maintains its low-friction properties over an extended period of time, while the competitive OEM-specified products fail prematurely.

Performance for the real world.

As you can see from the figures, our lubricants clearly outperform many competitive products. For instance, figure 1 indicates that Dow Corning® 111 Silicone Compound and Molykote® G-807 Low Friction Silicone Compound withstand high temperatures by nearly 49 percent over another synthetic brake caliper grease, and by 78 percent over a conventional petroleum grease.

Figure 2 indicates that water splash, a tough environmental enemy for brake system components, has minimal effect on our greases. Note that only 66 percent of the petroleum grease is still in place after water spray-off testing, while >97 percent of the lubricant from Dow Corning remains.

Of course, a major requirement for safe braking is corrosion resistance. Again, our lubricants outshine the competition. Figure 3 clearly illustrates this, showing a comparison between European OEM-specified PAGs and Molykote® brand brake caliper greases (silicone and polyalkylene glycol, or PAG, greases).

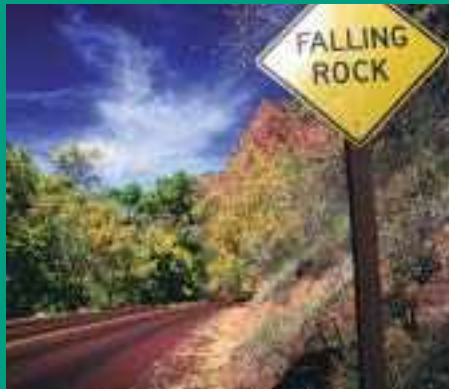

A comparison of the low temperature properties of our grease compared with European and Japanese OEM-specified PAGs is illustrated in figure 6. Note that Molykote G-407 Anti-Fretting Grease has both the lowest starting torque and the lowest running torque of any of the tested greases, illustrating it maintains its properties even at low temperatures.

Again and again, tests demonstrate that lubricants from Dow Corning routinely outperform the competition. Curious about how one of our lubricants will hold up in your application? Let's discuss your needs and give you the answer.

Meeting industry standards

While Dow Corning products are approved to meet many OEM and supplier specifications, other approvals may be needed to meet certain requirements. No problem. We can assist you with this testing or, if appropriate, use our facilities to generate the supporting data required for your application.

Salt Spray Comparison
(ASTM B 117, 250 Hours)

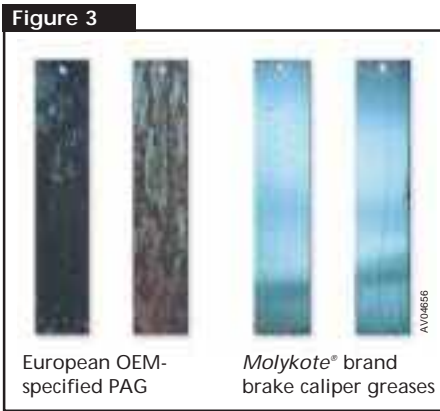

High Temperature Stability Comparison
(Fed-STD-791-321)

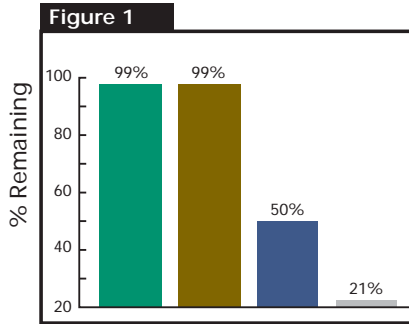

Water Spray-Off Comparison
(ASTM D 4049)

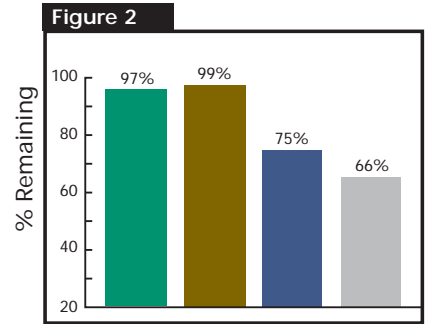

- Dow Corning® 111 Silicone Compound
- Molykote® G-807 Low Friction Silicone Compound
- Other synthetic brake caliper grease
- Conventional petroleum caliper grease

Stiction Comparison

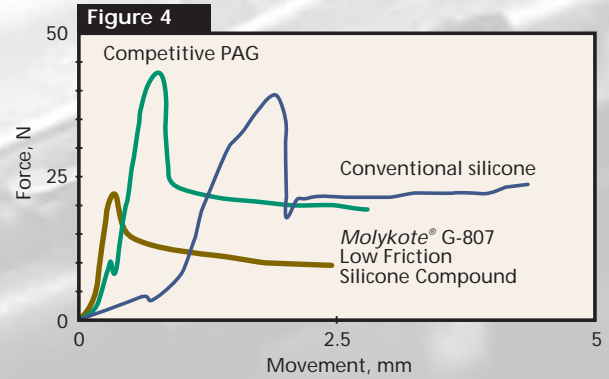

Fretting Comparison
(TE-77 High Frequency Reciprocating [HFR] machine)

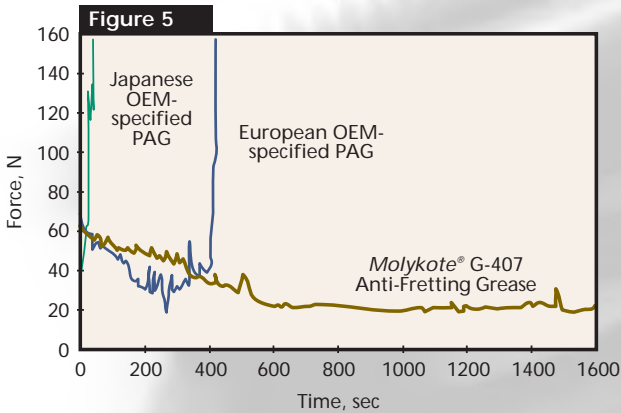

Low Temperature Properties Comparison
(ASTM D 1478 at -20°C)

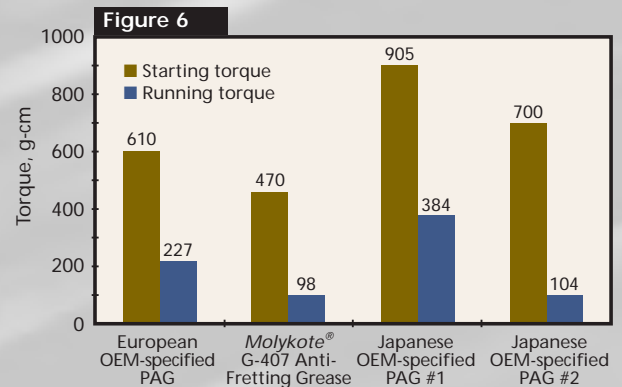



AV04644

A closer look: brake calipers

The metal-to-metal contact of direct-mounted calipers requires synthetic lubricants that can reduce fretting-type wear between the metal surfaces as well as provide good compatibility with rubber seals.

Tests prove that our lubricants provide high resistance to degradation by water and help prevent corrosion. Molykote specialty lubricants resist drying and hardening in high-heat applications offering long service life.

Proper pad, backing plate, and shim lubrication is essential in reducing noise and optimizing brake pad life.

The metal-to-rubber contact of most grommet-mounted calipers requires a silicone-based lubricant that can reduce the stiction between the mounting pin and the rubber without degrading the rubber material.

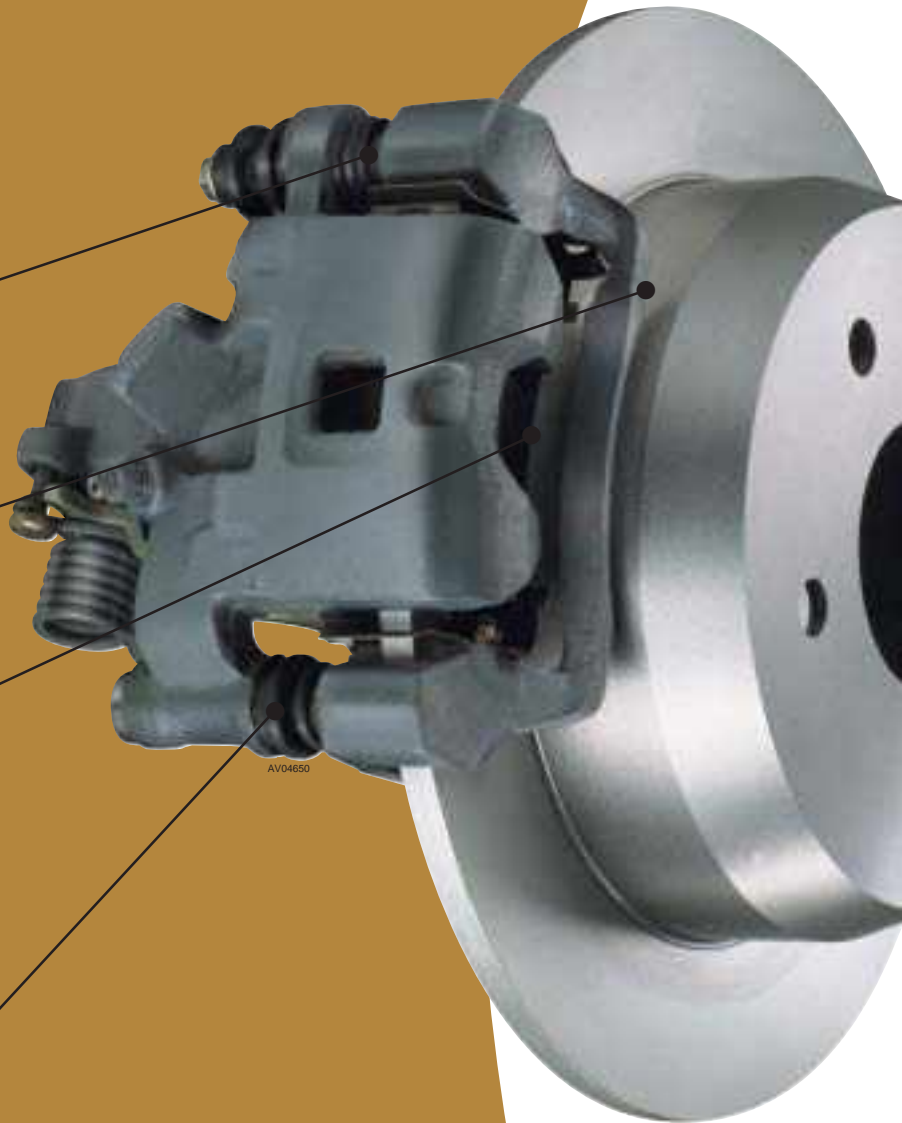

AV04650

Recommended solutions

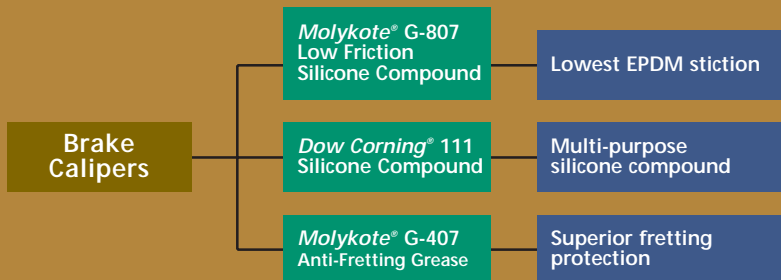

Recommended solutions

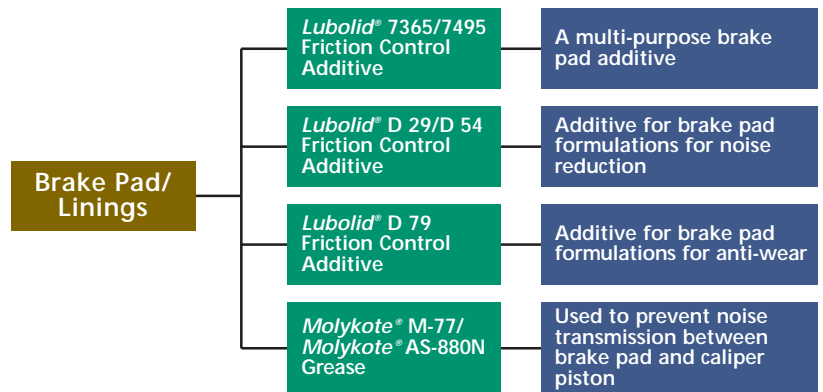

A closer look: brake pad/linings

To isolate transmitted vibration and reduce squeal, apply lubricating paste to the back side of the pads and the backing plates or shims.

Formulated into brake caliper pads and drum brake shoes, friction control lubricants can reduce heat, vibration, and noise.

Our friction control lubricants are environmentally acceptable.



AV04655

A closer look: drum brakes

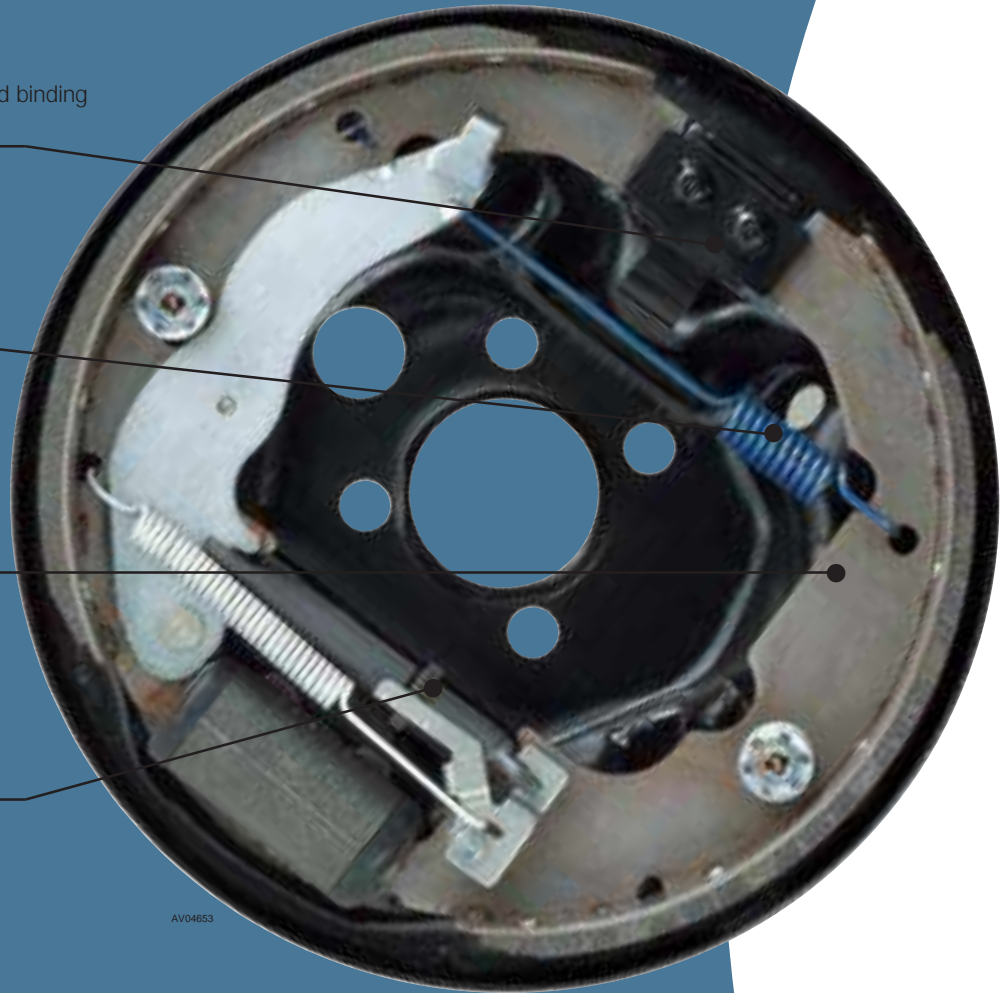

Reduce noise and binding at pivot points.

Reduce return spring noise.

Reduce friction and noise against backing plate.

Eliminate adjusting screw seizure.

AV04653

Recommended solutions

Drum Brakes

Molykote® D 321 R/
Dow Corning® 321
Dry Film Lubricant

Dry film coating does not attract dirt

Molykote® CU 7439 +
High Temperature
Copper Paste

Tenacious copper-fortified paste

Dow Corning® 1000
Anti-Seize Paste

Multi-purpose paste

Dow Corning® G-n
Paste

Lowest friction paste

Recommended solutions

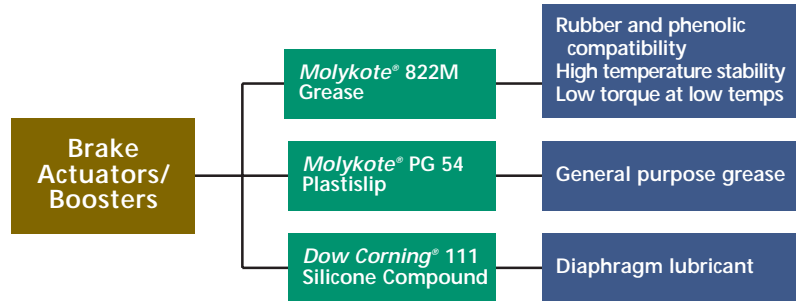

A closer look: brake actuators/boosters

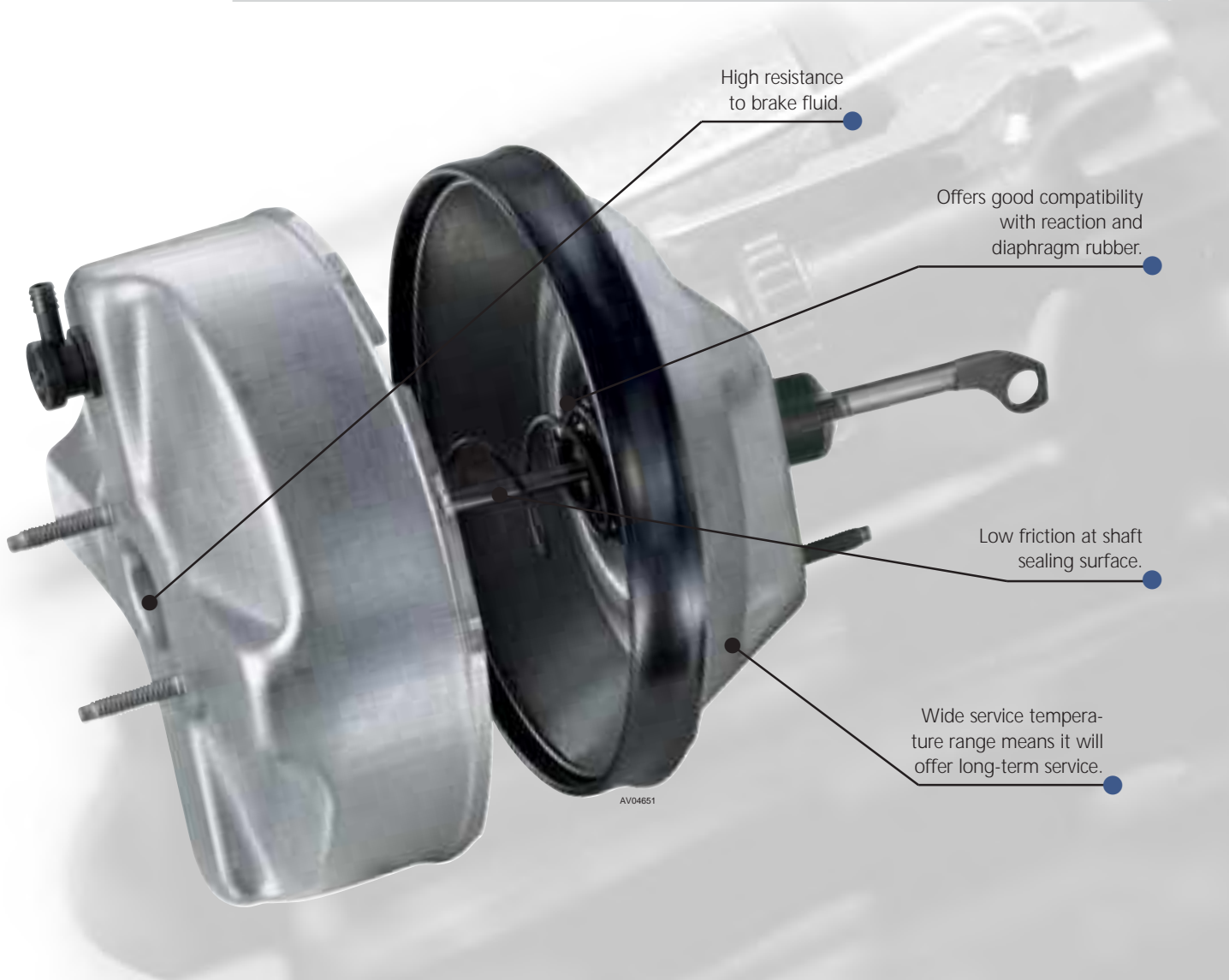

Beyond brakes: multi-technology solutions tackle multiple applications

Innovative materials technology is our greatest strength. It's designed into every one of our lubricants, adhesives, insulating materials, protection materials, sealing and gasketing materials, and torque transfer fluids. And it's backed by a service commitment that means you'll get answers to both design and processing questions.

We invite you to learn more about our multi-technology solutions to your applications by visiting our Web site at www.dowcorning.com/automotive. The site details specific application solutions for:

- body components
- brake systems
- chassis
- electrical components
- electronic components
- engine/drivetrain
- exterior lighting
- fuel systems

The site also leads you through a preliminary selection process to help you discover which of our products might best meet your needs.

To learn more

This brochure and the accompanying data sheets should give you a feel for the types of lubricants that we offer and which one might be best suited to your application. However, it's important that we discuss your needs to ensure that you're getting the best possible product for your application.

Once you're ready to move forward, contact us at www.molykote.com. We'll be glad to discuss your exact needs, provide you with a product sample, and link you with our application development and technical service people, if needed.

Our worldwide automotive centers are strategically located to meet your global demands. Whether you require global support for product development, application engineering, commercial supply, or manufacturing services, we're well positioned to help. Just ask.



AV09647





How To Contact Us

For nearly 60 years, OEM designers, maintenance and materials engineers around the world have trusted the Molykote brand for performance and expertise to solve or prevent lubrication problems. Molykote solutions are available through a distributor network of more than 3,000 channel partners around the globe. To learn more about our extensive product and service offering, visit www.molykote.com, or email industrial@dowcorning.com.

LIMITED WARRANTY INFORMATION – PLEASE READ CAREFULLY

The information contained herein is offered in good faith and is believed to be accurate. However, because conditions and methods of use of our products are beyond our control, this information should not be used in substitution for customer's tests to ensure that Dow Corning's products are safe, effective, and fully satisfactory for the intended end use. Suggestions of use shall not be taken as inducements to infringe any patent.

Dow Corning's sole warranty is that the product will meet the Dow Corning sales specifications in effect at the time of shipment.

Your exclusive remedy for breach of such warranty is limited to refund of purchase price or replacement of any product shown to be other than as warranted.

DOW CORNING SPECIFICALLY DISCLAIMS ANY OTHER EXPRESS OR IMPLIED WARRANTY OF FITNESS FOR A PARTICULAR PURPOSE OR MERCHANTABILITY.

DOW CORNING DISCLAIMS LIABILITY FOR ANY INCIDENTAL OR CONSEQUENTIAL DAMAGES.

We help you invent the future is a trademark of Dow Corning Corporation.

Dow Corning, Lubolid and Molykote are registered trademarks of Dow Corning Corporation.

©2004 Dow Corning Corporation. All rights reserved.

Form No. 10-9431A-01

DOW CORNING

*We help you
invent the future.™*

www.dowcorning.com

Maahantuoja:

 **YTM-Industrial**
INDUTRADE GROUP

Petikontie 20, 01720 Vantaa
Puh. 029 006 230, fax. 029 006 1230
www.ytm.fi, e-mail ytm.info@ytm.fi

Jälleenmyyjä:



We help you invent the future.™



Form No: 80-3625-01

AMP253-09

©2011 Dow Corning Corporation. All rights reserved.

Pictures with permission of R.D.S.O. Indian Railway.

Molykote and *Silastic* are registered trademarks of Dow Corning Corporation.

We help you invent the future is a trademark of Dow Corning Corporation.

Dow Corning is a registered trademark of Dow Corning Corporation.

DOW CORNING DISCLAIMS LIABILITY FOR ANY INCIDENTAL OR CONSEQUENTIAL DAMAGES.

DOW CORNING SPECIFICALLY DISCLAIMS ANY OTHER EXPRESS OR IMPLIED WARRANTY OF FITNESS FOR A PARTICULAR PURPOSE OR MERCHANTABILITY.

Your exclusive remedy for breach of such warranty is limited to refund of purchase price or replacement of any product shown to be other than as warranted.

Dow Corning's sole warranty is that our products will meet the sales specifications in effect at the time of shipment.

be taken as inducements to infringe any patent.

The information should not be used in substitution for customer's tests to ensure that our products are safe, effective and fully satisfactory for the intended end use. Suggestions of use shall not

be taken as inducements to infringe any patent.

LIMITED WARRANTY INFORMATION - PLEASE READ CAREFULLY



Assembly and Maintenance Solutions for Railway Applications

On track with *Dow Corning*®,
Silastic® and *Molykote*® products





AVXXXXX, Front Cover: AVXXXXX

Dow Corning Corporation

Dow Corning[®], *Silastic*[®] and *Molykote*[®] brand lubricants and sealants are used in assembly and maintenance practices for railway applications, recognized and approved by leading railway companies.

This product reference guide is designed to help you select the right *Dow Corning*[®], *Silastic*[®] or *Molykote*[®] product for a wide range of locomotive applications. If you need help determining which product is right for you, please contact your Dow Corning representative. For additional information on our complete product line, visit dowcorning.com/india.

For optimal performance and efficient locomotive maintenance, specify lubricants and sealants from Dow Corning.



Applications

- ① **Engine:** cylinders, bearing stud, mounting bolts, generator cap, cam, vibration damper, liner sleeve
- ② **Bogie/Truck:** traction motor, roller suspension, wheel assembly, axle box, gear case, center pivot
- ③ **Brake System:** O-rings, seals and rubber components in valves, assemblies, pistons
- ④ **Couplers:** body, head, knuckle, pin, gear teeth

Other: fasteners, studs, nuts, bolts, screws, doors, windows, joints, gaskets, bushings

Products

Assembly pastes, anti-seize pastes, protective lubricants, anti-friction coatings, greases, sealants, cleaners, gasket release coatings

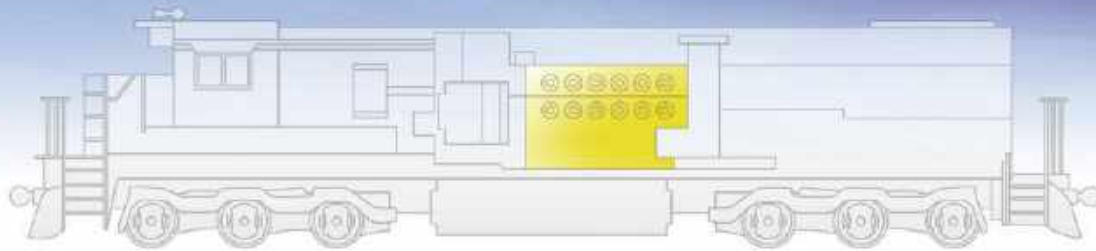

Applications

Cylinders, bearing stud, mounting bolts, generator cap, cam, vibration damper, liner sleeve

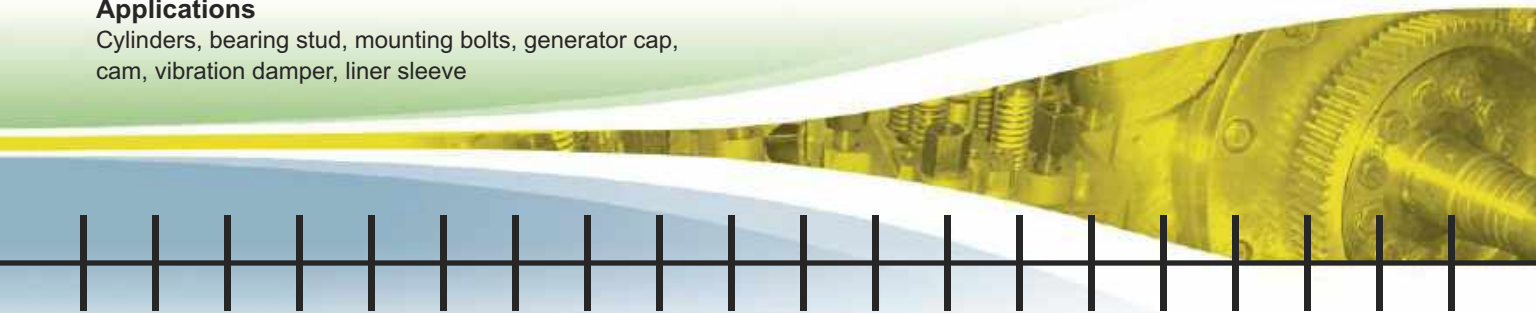

AV16009



AV16008



AVXXXXX



Application	Recommended Product	Function	Benefits	Properties	
Cam gear, cam nut, cam lobes on diesel engines	<i>Molykote</i> [®] Z Powder	Assembly of cam shaft	<ul style="list-style-type: none"> • Wide service temperature range • High load carrying capacity • Very low COF 	Service temperature (°C)	-226 to +400
				Almen Wieland OK Load (N)	>20000
				COF (press fit)	0.04
Vibration damper on diesel engines	<i>Molykote</i> [®] G Paste	Running-in maintenance	<ul style="list-style-type: none"> • High load carrying capacity • Heat resistant 	Four ball weld load (kg)	280
				Service temperature (°C)	-20 to +400 (solid)
Main Base to cylinder block sealing	<i>Molykote</i> [®] G Paste	Vibration dampening	<ul style="list-style-type: none"> • High load carrying capacity • Heat resistant 	Four ball weld load (kg)	280
				Service temperature (°C)	-20 to +400 (solid)
Main Base to cylinder block sealing	<i>Molykote</i> [®] G Paste	Sealing	<ul style="list-style-type: none"> • High load carrying capacity • Heat resistant 	Four ball weld load (kg)	280
				Service temperature (°C)	-20 to +400

AV16015



Application	Recommended Product	Function	Benefits	Properties	
Main bearing studs, nuts, nut faces and washer sheets, generator cap screw and mounting bolts on diesel engines	Molykote® G Paste	Assembly paste	<ul style="list-style-type: none"> • Wide service temperature range • Good corrosion resistance • High load carrying capacity • Low coefficient of friction (COF) 	Service temperature (°C)	-20 to +400 (solid)
				Penetration (1/10 mm)	310 to 360
				Copper corrosion	1a
				Four ball weld load (kg)	280
				COF (press fit)	0.10
Heavy duty cylinder head studs and nuts on typical 12 cylinder engines	Molykote® G Paste	Assembly paste	<ul style="list-style-type: none"> • Wide service temperature range • Good corrosion resistance • High load carrying capacity • Low COF 	Service temperature (°C)	-20 to +400 (solid)
				Penetration (1/10 mm)	310 to 360
				Copper corrosion	1a
				Four ball weld load (kg)	280
				COF (press fit)	0.10

AV16011



AVXXXXX



Application	Recommended Product	Function	Benefits	Properties	
Cylinder liner O-ring gasket	Dow Corning® 4 Electrical Insulating Compound	Protective lubrication	<ul style="list-style-type: none"> • Broad service temperature range • Low evaporation 	Service temperature (°C)	-57 to +200
				Penetration (1/10 mm)	220 to 250
				Evaporation (24 hr/200°C)	1.40%

Bogies (Trucks)

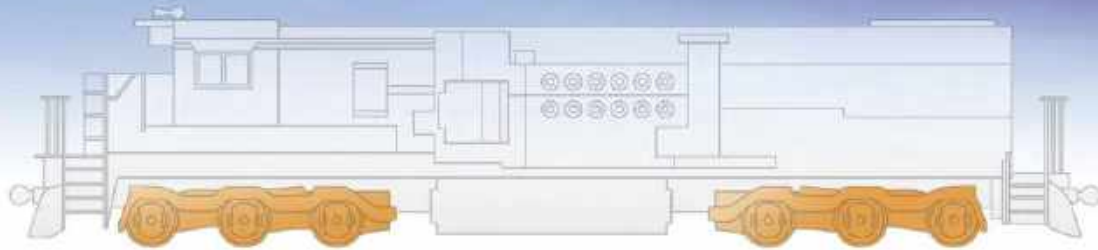

AVXXXX

Applications

Traction motor, roller suspension, axle box, wheel disk



AV04052



AVXXXXX



AVXXXXX



Application	Recommended Product	Function	Benefits	Properties	
Roller suspension Assembly of bearings	<i>Molykote</i> [®] G-n Plus Solid Lubricant Paste	Assembly	<ul style="list-style-type: none"> • High service temperatures • Gives press fit without chatter or stick slip 	Service temperature (°C)	-25 to +399
				COF (press fit)	0.08
				Weld load (kg)	499
Axle box Assembly of bearings	<i>Molykote</i> [®] G-n Plus Solid Lubricant Paste	Assembly	<ul style="list-style-type: none"> • High service temperatures • Gives press fit without chatter or stick slip 	Service temperature (°C)	-25 to +399
				COF (press fit)	0.08
				Weld load (kg)	499
Wheel disk Assembly on hub	<i>Molykote</i> [®] G-n Plus Solid Lubricant Paste	Assembly	<ul style="list-style-type: none"> • High service temperatures • Gives press fit without chatter or stick slip 	Service temperature (°C)	-25 to +399
				COF (press fit)	0.08
				Weld load (kg)	499

AVXXXXX



Application	Recommended Product	Function	Benefits	Properties	
Parting line, frame cover, outgoing cable bush, split field coils, gaps, terminal pole bolts, armature, stator, commentator	<i>Silastic</i> ® 1080 RTV Neutral Cure Silicone Sealant	Sealing of parting line, frame cover, outgoing cable bush, split field coils, gaps, terminal pole bolts, armature, stator, commentator, etc., of traction machines	<ul style="list-style-type: none"> • Wide temperature range • Non-slump • Neutral cure • Good adhesion to many substrates 	Temperature range (°C)	-40 to +150
				Specific gravity	1.03
				Extrusion rate (g/min)	420
				Tack free time (min)	15
				Durometer hardness (Shore A)	30
				Tensile strength (KPa)	1800
Elongation at break (%)	400				



AV14150



Application	Recommended Product	Function	Benefits	Properties	
End fitting bolts	<i>Molykote</i> ® G-n Plus Solid Lubricant Paste	Assembly	<ul style="list-style-type: none"> • High service temperature with reduced air access • Very low COF gives uniform clamping force 	Service temperature (°C)	-25 to +399
				COF (press fit)	0.08
				Weld load (kg)	499
Traction motor Assembly of bearings, pinion and gearwheel	<i>Molykote</i> ® G-n Plus Solid Lubricant Paste	Assembly	<ul style="list-style-type: none"> • High service temperatures • Gives press fit without chatter or stick slip 	Service temperature (°C)	-25 to + 399
				COF (press fit)	0.08
				Weld load (kg)	499

AV11267



Brake System

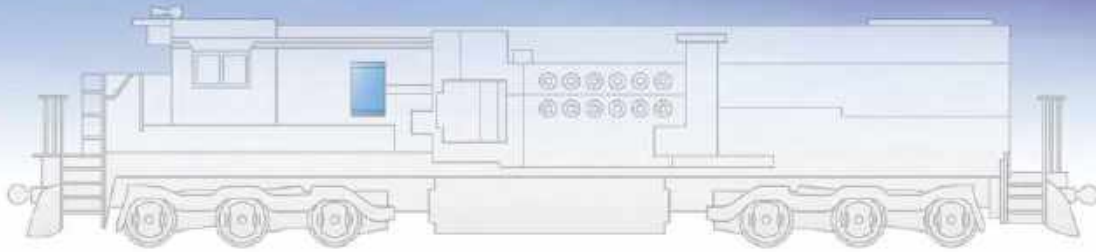

AVXXXX

Applications

O-rings, seals and rubber components in valves, assemblies, pistons



AV04680



Application	Recommended Product	Function	Benefits	Properties	
Rubber O-rings, seals and rubber components in C3W/C3W2 type brake system distributor valve, service portion valve, check valve, release valves, emergency portion, spool, spillover check valve, in-shot piston, in-shot check valve	Molykote® 55 O-Ring Grease	Lubrication	<ul style="list-style-type: none"> • Wide service temperature range • Good corrosion protection • High oxidation resistance 	Service temperature (°C)	-65 to +175
				Emcor Corrosion Test	(No corrosion)
				Oxidation resistance (99°C/500 hrs) (MPa)	0.01

AV04630



Application	Recommended Product	Function	Benefits	Properties	
Rubber O-rings, seals and rubber components in KEO type distributor valve and CCB 1.5 brake system	Molykote® 111 Silicone Compound	Lubrication	<ul style="list-style-type: none"> • Excellent rubber lubrication • Wide service temperature range • Non-melting • Resistant to variety of organic and inorganic chemicals • Excellent water resistance 	Service temperature (°C)	-40 to +200
				Dropping point	None

Couplers



Applications

Coupler body, head, knuckle, pin, gear teeth

AVXXXX

AV/XXXXXX



AV/16008



Application	Recommended Product	Function	Benefits	Properties	
CBC coupler: Bare areas, head, body and knuckle	<i>Molykote</i> ® D-321 R Anti-Friction Coating Spray	Lubrication	<ul style="list-style-type: none"> • Air drying • Good emergency lubricant • Wide service temperature range 	Curing time (min/°C)	5/23
				Falex load carrying capacity (on phosphated surface) (N)	12500
				Service temperature (°C)	-180 to +450
Gear teeth	<i>Molykote</i> ® Longterm 00 Fluid Grease	Lubrication	<ul style="list-style-type: none"> • High load bearing capacity • Good corrosion protection 	Four ball weld load (N)	3400
				Almen-Wieland OK Load (N)	12000
				SKF Emcor Corrosion Test (sea water)	1

Other



Applications

Fasteners, studs, nuts, bolts, screws, doors, windows, joints, gaskets, bushings

AV/XXXXXX

AV16008



Application	Recommended Product	Function	Benefits	Properties	
Fasteners, studs, nuts, bolts, screws (other than in high-temperature areas)	<i>Molykote</i> ® P-74 Super Anti-Seize	Anti-seize lubrication	<ul style="list-style-type: none"> • Synthetic base oil • High load carrying capacity • Wide service temperature range • Effective as dry lubricant, even at high temperatures 	Specific gravity	1.21
				Penetration (1/10 mm)	280-310
				Base oil	Synthetic
				Metal content	Metal free
				Weld load (N)	4800
				Service temperature (°C)	-40 to +1500 (as dry lubricant)

AV16007



Application	Recommended Product	Function	Benefits	Properties	
Exhaust manifold areas: Fasteners, nuts and studs	<i>Molykote</i> ® 1000 Solid Lubricant Paste	High-temperature anti-seize lubrication	<ul style="list-style-type: none"> • High service temperature range • Good corrosion protection • Higher consistency for reliable sealing 	Specific gravity	1.26
				Penetration (1/10 mm)	280-310
				Weld load (N)	4800
				Service temperature (°C)	-18 to +1093
Door hinges, door locks	<i>Molykote</i> ® D-321 R Anti-Friction Coating	Dry lubrication	<ul style="list-style-type: none"> • Cures at room temperature • Ease of application • Extreme service temperatures (low and high) 	Curing system	Room temperature
				Service temperature (°C)	-180 to +450
				COF (press fit, μ)	0.075

AVXXXXX



AVXXXXX



Application	Recommended Product	Function	Benefits	Properties	
Door rubber, window frames, look-out glass, metal joints	Dow Corning® 733 Glass and Metal Sealant	Sealing	<ul style="list-style-type: none"> • Fast cure • High tensile strength • Cures to form tough rubber • Highly flexible (good damping effect) • Good unprimed adhesion to most glass, metals, plastics 	Tensile strength (MPa)	2.3
				Durometer hardness (Shore A)	25
				Elongation at break (%)	500
				Tack-free time (min)	15

AV04346



Application	Recommended Product	Function	Benefits	Properties	
General purpose	Dow Corning® OS-2 Silicone Cleaner and Solvent	Cleaning	<ul style="list-style-type: none"> • Completely ozone safe • Non-toxic • Low surface tension (easy spreading) 		

AVXXXXX



Application	Recommended Product	Function	Benefits	Properties	
Fibrous packing gaskets	Dow Corning® 1-2577 Conformal Coating	Protection/release	<ul style="list-style-type: none"> • One part, room temperature cure • Easy application by brushing, dipping, spraying or flow coating • Stable and flexible from -100°C to +150°C 	Color	Clear
				Specific gravity	1.11
				Drying time at room temperature (max)	60 min



Dow Corning products used for maintenance operations for railway applications

Product	Application
<i>Dow Corning</i> ® 4 Electrical Insulating Compound	Engine: Cylinder liner O-ring gasket
<i>Molykote</i> ® G Paste	Diesel Engine: Main bearing studs, nuts, nut faces and washer sheets, generator cap screw, mounting bolts, cam gear, cam nut, cam lobes, vibration damper, sealing liner sleeve to engine block 12-Cylinder Engine: Heavy duty cylinder head studs and nuts
<i>Molykote</i> ® Z Powder	Diesel Engine: Cam gear, cam nut, cam lobes

Dow Corning products used for maintenance operations for railway applications *CONTINUED*

Product	Application
<i>Molykote</i> ® G-n Plus Solid Lubricant Paste	Traction Motor: Bearings, pinion, gearwheel, end fitting bolts Roller Suspension: Bearings Axle Box: Bearings Wheel Disk
<i>Silastic</i> ® 1080 RTV Neutral Cure Silicone Sealant	Traction Motor: Parting line, frame cover, outgoing cable bush, split field coils, gaps, terminal pole bolts, armature, stator, commutator
<i>Molykote</i> ® 55 O-Ring Grease	Rubber O-rings, seals and rubber components in C3W/C3W2 type brake system distributor valve, service portion valve, check valve, release valves, emergency portion, spool, spillover check valve, in-shot piston, in-shot check valve
<i>Molykote</i> ® 111 Silicone Compound	Rubber O-rings, seals and rubber components in KEO type brake system distributor valve and CCB 1.5 brake system



Product	Application
<i>Molykote</i> ® D-321 R Anti-Friction Coating Spray	CBC Coupler: Bare areas, head, body and knuckle Door hinges, door locks
<i>Molykote</i> ® Longterm 00 Fluid Grease	Gear teeth, semi-fluid grease fortified with solid lubricant
<i>Molykote</i> ® P-74 Super Anti-Seize	Fasteners, studs, nuts, bolts, screws (not in high-temperature areas)
<i>Molykote</i> ® 1000 Solid Lubricant Paste	Exhaust Manifold Areas: fasteners, nuts and studs
<i>Silastic</i> ® 733 Glass & Metal Sealant	Door rubber, window frames, look-out glass, metal joints
<i>Molykote</i> ® OS-2 Silicone Cleaner and Surface Prep Solvent	General purpose

Dow Corning products used for maintenance operations for railway applications *CONTINUED*

Product	Application
<i>Molykote</i> ® BR 2 Plus High Performance Grease	Equalizer and compensating beam arrangement pin
<i>Molykote</i> ® Separator Spray Oil	Car body bushings, nitrile/nylon bushing inside area and side bearer pads
<i>Dow Corning</i> ® 1-2577 Low-VOC Conformal Coating	Fibrous packing gaskets



Learn More

Dow Corning® brand sealants, *Silastic*® brand silicone rubbers and *Molykote*® brand lubricants are available through a distributor network of more than 3,000 channel partners worldwide. And, Dow Corning has Lubricant Expertise Centers strategically located globally to provide you with expert technical service and support.

Learn more now about our extensive product and service offering by visiting dowcorning.com, molykote.com or e-mail industrial@dowcorning.com.